

SHARP

SERVICE MANUAL

SEJB37GQ2*S02
Issued: 9th June '00

SQUAD CHASSIS

PAL SYSTEM COLOUR TELEVISION

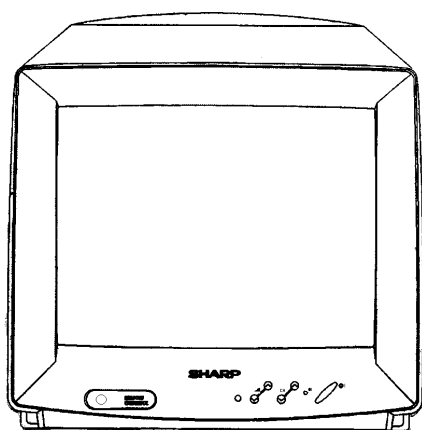

**MODELS: 37GQ-20S
37GQ-21S**

In the interests of user safety (required by safety regulations in some countries) the set should be restored to its original condition and only parts identical to those specified should be used.

CONTENTS

ELECTRICAL SPECIFICATION.....	2	SCHEMATIC DIAGRAM, WAVE FORMS.....	13
IMPORTANT SERVICE NOTES.....	3	PART LIST.....	18
SERVICE ADJUSTEMENTS.....	4	TROUBLESHOOTING TABLES.....	23
PRINTED WIRING BOARDS.....	11		

SHARP CORPORATION

This document has been published to be used for after sales service only.

ELECTRICAL SPECIFICATIONS

- | | |
|--|--|
| <ul style="list-style-type: none"> •Power Input220V-240 Volts AC 50Hz •Power Consumption <ul style="list-style-type: none"> Normal Operating.....30W Stand-by Operating.....7.5W
(Method IEC60107) •Audio Power Output Rating2W (MPO)
Speaker.....32Ω 2W, 8cm Round, 1pc Convergence.....Self Converging System Focus.....Bi-Potencial Electrostatic Sweep Deflection.....Magnetic •Picture Intermediate Frecuencies
B/G.....38.9MHz | <ul style="list-style-type: none"> •Sound Carrier Trap
B/G.....33.4MHz •Adjacent Sound Carrier Trap
B/G.....40.4MHz •Adjacent Picture Carrier Trap
B/G.....30.9MHz •Aerial Input Impedance
VHF/UHF.....75 ohm Unbalanced •Tuning Ranges
B/G.....48.25MHz thru 855.25 MHz

CATV Special Channels |
|--|--|

•White Level
Set brightness control to get total picture tube cathode current of 600 milliamperes under no signal condition. Maximum necessary correction of each picture tube cathode current to get 8550 degree K-20 MPCD screen temperature should not exceed 15% of its original value.

X=0.290 Y=0.300

Specifications are subject to change without prior notice.

WARNING

The chassis in this receiver is partially live. Always use an isolation transformer when servicing this chassis.
To prevent electric shock, do not remove cover. No user-serviceable parts inside. Refer servicing to qualified service personnel.

MODEL DESTINATION & DIFFERENCES:

37GQ-20S DE: Autria	37GQ-20S NL: Holland
37GQ-20S DES: Germany (Silver)	37GQ-20S SE: Sweden
37GQ-20S ES: Spain	37GQ-21S ESY: Spain (Yellow, with headphones)
37GQ-20S IT: Italy	37GQ-21S ESR: Spain (Red, with headphones)

IMPORTANT SERVICE NOTES

Maintenance and repair of this receiver should be done by qualified service personnel only.

SERVICING OF HIGH VOLTAGE SYSTEM AND PICTURE TUBE

When servicing the high voltage system, remove static charge from it by connecting a 10K ohm resistor in series with an insulated wire (such as test probe) between picture tube ground tag and high voltage lead. (AC line cord should be disconnected from AC outlet).

1. The Picture tube in this receiver employs Integral Implosion protection.
2. Replace with tube of the same type number for continued safety.
3. Do not lift picture tube by the neck.
4. Handle the picture tube only when wearing shatterproof goggles and after discharging the high voltage completely.

X-RAY

This receiver is designed so that any X-Ray radiation is kept to an absolute minimum. Since certain malfunctions and servicing may produce potentially hazardous radiation with prolonged exposure at close range, the following precautions should be observed:

1. When repairing the circuit, be sure not to increase the high voltage to more than 25.5 KV, (at beam 1000 μ A) for the set.
2. To keep the set in a normal operation, be sure to make it function on 22.4KV \pm 1.5KV (at beam 800 μ A) in the case of the set. The set has been factory - adjusted to the above mentioned high voltage. Always check the high voltage if there is any possibility that it might have changed as a result of the repair.
3. Do not substitute a picture tube with unauthorized types and/or brands which may cause excess X-Ray radiation.

BEFORE RETURNING THE RECEIVER

In addition to the above checks, the following safety checks should also be carried out before returning the unit to the user.

1. Inspect all leads and dress to make certain that the leads are not pinched or that hardware is not lodged between the chassis and other metal parts.
2. Inspect all protective devices such as non-metallic control knobs, insulating fish papers, cabinet backs, adjustment and compartment covers or shields, insulation resistor-capacity networks, mechanical insulators etc.

SERVICE ADJUSTMENT

•SERVICE MODE FUNCTION

This mode function is provided to assist with the settings of those adjustments that may vary from one Picture Tube to another, or between models.

In order to use the Service Mode

1. Press main switch to OFF.
2. Connect Test Pattern signal to antenna terminal.
3. Press ∇ \triangleleft , CH ∇ and main switch to ON simultaneously or press \wedge \triangleleft , CH \wedge and main switch to ON simultaneously.
4. -SERVICE- will appear on screen. Service mode is now entered.
5. Select adjustment using buttons \wedge CH \wedge .

To exit Service Mode, press main switch to OFF or press MENU button on R/C.

	Displayed on screen	Hexadecimal / Decim. Range	Function
a.	SERVICE		Indicates operative Service Mode.
b.	NVM		Access to NVM memory
c.	AGC GAIN	00 ~ 03H	Auto Gain Control
d.	AGC STR	00 ~ 63H	Auto Gain Starting Point
e.	PLL	S, L, VL, N	Line PLL time constant
	PAL	4-43, 3-58, SECAM, NTSC	Colour system.
		4-43, NTSC 3-58, AUTO PNS, AUTO PN	
f.	AUTO	AUTO, 50HZ, 60HZ	Field Frequency
g.	B-GAIN	0 ~ 63d	Blue Gain
h.	G-GAIN	0 ~ 63d	Green Gain
i.	G-DC	0 ~ 63d	Green Cut
j.	R-GAIN	0 ~ 63d	Red Gain
k.	R-DC	0 ~ 63d	Red Cut
l.	HOR POS	0 ~ 63d	Horizontal Position shift
m.	VERT POS	0 ~ 63d	Vertical Position shift
n.	VERT AM	0 ~ 15d	Vertical Amplitude shift

6. For « a » Selection:

NVM storage location settings variants.

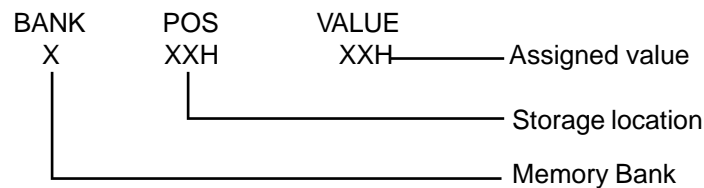

In order to have access to NVM «MENU» button should be pressed. To obtain a higher or lower Memory Bank, buttons ∇ \triangleleft \wedge should be pressed respectively. To have access to the desired Storage Location, buttons ∇ CH \wedge should be pressed, as required to obtain a higher or lower location, respectively.

Bear in mind that, for storage location indication a hexadecimal numerical system is used, instead of a decimal system.

0, 1, 2, 3, 4, 5, 6, 7, 8, 9, A, B, C, D, E, F, 10, 11,19, 1A, 1B, 1C, 1D, 1E, 1F, 20, 21, 99, 9A, 9B, 9C, 9D, 9E, 9F, A0, A1,, B0,, C0,, D0,E0,, F0, F1, F2, F3, F4, F5, F6, F7, F8, F9, FA, FB, FC, FD, FE, FF.

From the last location FF to the first 00 can be reached by increasing and from first to last by decreasing. Once the storage location to be varied has been selected, its value can be modified by the bits that form part of the storage location numerical buttons, numbers «0» to «7», respectively. This switches the binary number from and between 0 and 1 each time one of the buttons is pressed.

$$\langle\langle 0 \rangle\rangle: 2^0=1, \langle\langle 1 \rangle\rangle: 2^1=2, \langle\langle 2 \rangle\rangle: 2^2=4, \dots$$

7. For «b,c» and «g» thru «n» selections:

Adjustment to a selection can be made by pressing buttons ∇ \triangleleft \triangle \triangleright \wedge .

8. For «d» thru «f» selections:

Adjustment to a selection can be made by pressing button \triangleleft \triangle \triangleright \wedge .

NVM LIST DESCRIPTION			
BANK	ADDRESS	DESCRIPTION	VALUE
00H	00H	ZONE FOR TUNNING INFORMATION (BEGIN)	CAH
	3BH	ZONE FOR TUNNING INFORMATION (END)	10H
	3CH	STAND BY: 44H -> ON 40H -> OFF	44H
	3DH	OPTION BYTE: 10XXXXXX -> HOTEL MODE 1 (START IN PRG1. NO TUNNING OPTION. VOLUME LIMITATION). 11XXXXXX -> HOTEL MODE 2 (START IN PRG 1. NO TUNING OPTION. VOLUME LIMITATION. START IN SCART MODE. OUT FROM STDBY WITH SSW. XXDDDDDD -> VOLUME ATTENUATION: 0AH -> 100%, 00H -> 0%	00H
	3EH	DIODE_NVM: XXXXXXX0 -> SYMBOLIC OSD. XXXXXXX1 -> CHARACTER OSD XXXXXX1X -> ENGLISH LANGUAGE.	04H
	3FH	DIODE2_NVM: XXXXXXX1 -> FRENCH STANDARD XXXXX01X -> BG STANDARD XXXXX10X -> L/L' STANDARD XX1XXXXX -> AUDIO FOR UK X1XXXXXX -> AUTOINSTALLATION ON 1XXXXXXX -> ONLY UHF BAND.	00H
01H	00H	ZONE FOR TUNNING INFORMATION (BEGIN)	10H
	3BH	ZONE FOR TUNNING INFORMATION (END)	10H
	3DH	UHFLOW: LOW WINDOW LIMIT FOR UHF BAND	00H
	3EH	VHF3LOW: LOW WINDOW LIMIT FOR VHF3 BAND	00H
	3FH	VHF1LOW: LOW WINDOW LIMIT FOR VHF1 BAND	00H
02H	00H	RESERVED ZONE FOR PROGRAMME NAMES (BEGIN)	24H
	3FH	RESERVED ZONE FOR PROGRAMME NAMES (END)	24H

03H	00H	ONE CHIP REGISTER 00:	80H
	01H	ONE CHIP REGISTER 01:	05H
	02H	ONE CHIP REGISTER 02:	9FH
	03H	ONE CHIP REGISTER 03:	20H
	04H	ONE CHIP REGISTER 04:	00H
	05H	ONE CHIP REGISTER 05:	CCH
	06H	ONE CHIP REGISTER 06:	44H
	07H	ONE CHIP REGISTER 07:	34H
	08H	ONE CHIP REGISTER 08:	21H
	09H	ONE CHIP REGISTER 09:	A1H
	0AH	ONE CHIP REGISTER 0A:	32H
	0BH	ONE CHIP REGISTER 0B:	B2H
	0CH	ONE CHIP REGISTER 0C:	32H
	0DH	ONE CHIP REGISTER 0D:	20H
	0EH	ONE CHIP REGISTER 0E:	20H
	0FH	ONE CHIP REGISTER 0F:	18H
	10H	ONE CHIP REGISTER 10:	15H
	11H	ONE CHIP REGISTER 11:	00H
	12H	ONE CHIP REGISTER 12:	00H
	13H	ONE CHIP REGISTER 13:	20H
	14H	ONE CHIP REGISTER 14:	20H
	15H	ONE CHIP REGISTER 15:	00H
	16H	ONE CHIP REGISTER 16:	1FH
	17H	ONE CHIP REGISTER 17:	20H
	18H	ONE CHIP REGISTER 18:	2BH
	19H	ONE CHIP REGISTER 19:	00H
	1AH	ONE CHIP REGISTER 1A:	90H
	1BH	ONE CHIP REGISTER 1B:	90H
	1CH	ONE CHIP REGISTER 1C:	90H
	1DH	ONE CHIP REGISTER 1D:	00H
	1EH	ONE CHIP REGISTER 1E:	00H
	1FH	ONE CHIP REGISTER 1F:	00H
	20H	VPOS_50 (VERTICAL POSITION) 4/3 50 Hz.	12H
	21H	VAMP_50 (VERTICAL AMPLITUDE) 4/3 50 Hz	0FH
	22H	VPOS_60 (VERTICAL POSITION) 4/3 60 Hz	0FH
	23H	VAMP_60 (VERTICAL AMPLITUDE) 4/3 60 Hz	0FH
	24H	HSHIFT_60 (HORIZONTAL SHIFT) 60Hz	1DH
	25H	HSHIFT_50 (HORIZONTAL SHIFT) 50Hz	22H
	26H	FINVFH: STEP FOR FINE TUNING IN VHF BAND	00H
	27H	VHF1_STEP: THICK TUNING STEP FOR VHF1 BAND	A4H
	28H	VHF3_STEP: THICK TUNING STEP FOR VHF3 BAND	55H
	29H	UHF_STEP: THICK TUNING STEP FOR UHF BAND	55H
	2AH	LP_COARSE: THICK TUNING ADJUSTMENT FOR L'	02H
	2BH	BG_COARSE: THICK TUNING ADJUSTMENT FOR L AND BG	0AH
	2CH	BG_FINE: FINE TUNING ADJUSTMENT FOR L AND BG	00H
	2DH	LP_FINE: FINE TUNING ADJUSTMENT FOR L'	00H
	2EH	DELAY SEARCH: XXXXXXXX0 -> SHOWS 'PROGRAMME -' DURING AUTOSEARCH. XXXXXXXX1 -> SHOWS 'AUTO SEARCH' DURING AUTOSEARCH	00H
	2FH	VHF1_SP: STEP FOR AUTO SEARCH IN VHF1 BAND	0AH
	30H	VHF3_SP: STEP FOR AUTO SEARCH IN VHF3 BAND	05H
	31H	UHF_SP: STEP FOR AUTO SEARCH IN UHF BAND	03H
	32H	OLD_PROGRAM: FOR FLASHBACK RETURN	02H
	33H	UHFHIGH: UPPER WINDOW LIMIT FOR UHF	01H
	34H	VHF3HIGH: UPPER WINDOW LIMIT FOR VHF3	01H

	35H	VHF1HIGH: UPPER WINDOW LIMIT FOR VHF1	01H
	36H	PRG_NUMBER: CURRENT PROGRAMME NUMBER	03H
	37H	WAITSUP: UPPER LIMIT DELAY TIME FOR AUTOSEARCH.	0FH
	38H	WAITINF: LOWER LIMIT DELAY TIME FOR AUTOSEARCH	03H
	3BH	SCART BLOKING: - 00H = NO SCARTBLOKING - 01H = SCART BLOKING WHEN ANY PR. IS IN CHILD LOCK MODE.	00H Do not use. Just for UK models
	3CH	RET_COL: DELAY IN COLOUR IDENTIFICATION IN AUTO MODE.	40H
	3FH	CHECKSUM	7EH
04H	00H	ONE CHIP REGISTER 00:	80H
	01H	ONE CHIP REGISTER 01:	05H
	02H	ONE CHIP REGISTER 02:	9FH
	03H	ONE CHIP REGISTER 03:	20H
	04H	ONE CHIP REGISTER 04:	00H
	05H	ONE CHIP REGISTER 05:	CCH
	06H	ONE CHIP REGISTER 06:	44H
	07H	ONE CHIP REGISTER 07:	34H
	08H	ONE CHIP REGISTER 08:	21H
	09H	ONE CHIP REGISTER 09:	A1H
	0AH	ONE CHIP REGISTER 0A:	32H
	0BH	ONE CHIP REGISTER 0B:	B2H
	0CH	ONE CHIP REGISTER 0C:	32H
	0DH	ONE CHIP REGISTER 0D:	20H
	0EH	ONE CHIP REGISTER 0E:	20H
	0FH	ONE CHIP REGISTER 0F:	18H
	10H	ONE CHIP REGISTER 10:	1FH
	11H	ONE CHIP REGISTER 11:	00H
	12H	ONE CHIP REGISTER 12:	00H
	13H	ONE CHIP REGISTER 13:	20H
	14H	ONE CHIP REGISTER 14:	20H
	15H	ONE CHIP REGISTER 15:	00H
	16H	ONE CHIP REGISTER 16:	1FH
	17H	ONE CHIP REGISTER 17:	20H
	18H	ONE CHIP REGISTER 18:	2BH
	19H	ONE CHIP REGISTER 19:	00H
	1AH	ONE CHIP REGISTER 1A:	90H
	1BH	ONE CHIP REGISTER 1B:	90H
	1CH	ONE CHIP REGISTER 1C:	90H
	1DH	ONE CHIP REGISTER 1D:	00H
	1EH	ONE CHIP REGISTER 1E:	00H
	1FH	ONE CHIP REGISTER 1F:	00H
	20H	VPOS_50 (VERTICAL POSITION) 4/3 50 Hz.	12H
	21H	VAMP_50 (VERTICAL AMPLITUDE) 4/3 50 Hz	0FH
	22H	VPOS_60 (VERTICAL POSITION) 4/3 60 Hz	0FH
	23H	VAMP_60 (VERTICAL AMPLITUDE) 4/3 60 Hz	0FH
	24H	HSHIFT_60 (HORIZONTAL SHIFT) 60Hz	1DH
	25H	HSHIFT_50 (HORIZONTAL SHIFT) 50Hz	22H
	26H	FINVFH: STEP FOR FINE TUNING IN VHF BAND	00H
	27H	VHF1_STEP: THICK TUNING STEP FOR VHF1 BAND	A4H
	28H	VHF3_STEP: THICK TUNING STEP FOR VHF3 BAND	55H
	29H	UHF_STEP: THICK TUNING STEP FOR UHF BAND	55H
	2AH	LP_COARSE: THICK TUNING ADJUSTMENT FOR L'	02H
	2BH	BG_COARSE: THICK TUNING ADJUSTMENT FOR L AND BG	0AH
	2CH	BG_FINE: FINE TUNING ADJUSTMENT FOR L AND BG	00H
	2DH	LP_FINE: FINE TUNING ADJUSTMENT FOR L'	00H
	2EH	DELAY SEARCH: XXXXXXXX0 -> SHOWS 'PROGRAMME -' DURING AUTOSEARCH. XXXXXXXX1 -> DHOWS 'AUTO SEARCH' DURING AUTOSEARCH	00H

	2FH	VHF1_SP: STEP FOR AUTO SEARCH IN VHF1 BAND	0AH
	30H	VHF3_SP: STEP FOR AUTO SEARCH IN VHF3 BAND	05H
	31H	UHF_SP: STEP FOR AUTO SEARCH IN VHF BAND	03H
	32H	OLD_PROGRAM: FOR FLASHBACK RETURN	02H
	33H	UHFHIGH: UPPER WINDOW LIMIT FOR UHF	01H
	34H	VHF3HIGH: UPPER WINDOW LIMIT FOR VHF3	01H
	35H	VHF1HIGH: UPPER WINDOW LIMIT FOR VHF1	01H
	36H	PRG_NUMBER: CURRENT PROGRAMME NUMBER	03H
	37H	WAITSUP: UPPER LIMIT DELAY TIME FOR AUTOSEARCH.	0FH
	38H	WAITINF: LOWER LIMIT DELAY TIME FOR AUTOSEARCH	03H
	3BH	SCART BLOKING: - 00H = NO SCARTBLOKING - 01H = SCART BLOKING WHEN ANY PR. IS IN CHILD LOCK MODE.	00H Do not use. Just for UK models
	3CH	RET_COL: DELAY IN COLOUR IDENTIFICATION IN AUTO MODE.	40H
	3FH	CHECKSUM	7EH
05H	00H	ONE CHIP REGISTER 00:	80H
	01H	ONE CHIP REGISTER 01:	05H
	02H	ONE CHIP REGISTER 02:	9FH
	03H	ONE CHIP REGISTER 03:	20H
	04H	ONE CHIP REGISTER 04:	00H
	05H	ONE CHIP REGISTER 05:	CCH
	06H	ONE CHIP REGISTER 06:	44H
	07H	ONE CHIP REGISTER 07:	34H
	08H	ONE CHIP REGISTER 08:	21H
	09H	ONE CHIP REGISTER 09:	A1H
	0AH	ONE CHIP REGISTER 0A:	32H
	0BH	ONE CHIP REGISTER 0B:	B2H
	0CH	ONE CHIP REGISTER 0C:	32H
	0DH	ONE CHIP REGISTER 0D:	20H
	0EH	ONE CHIP REGISTER 0E:	20H
	0FH	ONE CHIP REGISTER 0F:	18H
	10H	ONE CHIP REGISTER 10:	1FH
	11H	ONE CHIP REGISTER 11:	00H
	12H	ONE CHIP REGISTER 12:	00H
	13H	ONE CHIP REGISTER 13:	20H
	14H	ONE CHIP REGISTER 14:	20H
	15H	ONE CHIP REGISTER 15:	00H
	16H	ONE CHIP REGISTER 16:	1FH
	17H	ONE CHIP REGISTER 17:	20H
	18H	ONE CHIP REGISTER 18:	2BH
	19H	ONE CHIP REGISTER 19:	00H
	1AH	ONE CHIP REGISTER 1A:	90H
	1BH	ONE CHIP REGISTER 1B:	90H
	1CH	ONE CHIP REGISTER 1C:	90H
	1DH	ONE CHIP REGISTER 1D:	00H
	1EH	ONE CHIP REGISTER 1E:	00H
	1FH	ONE CHIP REGISTER 1F:	00H
	20H	VPOS_50 (VERTICAL POSITION) 4/3 50 Hz.	12H
	21H	VAMP_50 (VERTICAL AMPLITUDE) 4/3 50 Hz	0FH
	22H	VPOS_60 (VERTICAL POSITION) 4/3 60 Hz	0FH
	23H	VAMP_60 (VERTICAL AMPLITUDE) 4/3 60 Hz	0FH
	24H	HSHIFT_60 (HORIZONTAL SHIFT) 60Hz	1DH
	25H	HSHIFT_50 (HORIZONTAL SHIFT) 50Hz	22H
	26H	FINVFH: STEP FOR FINE TUNING IN VHF BAND	00H
	27H	VHF1_STEP: THICK TUNING STEP FOR VHF1 BAND	A4H
	28H	VHF3_STEP: THICK TUNING STEP FOR VHF3 BAND	55H
	29H	UHF_STEP: THICK TUNING STEP FOR UHF BAND	55H
	2AH	LP_COARSE: THICK TUNING ADJUSTMENT FOR L'	02H

	2BH	BG_COARSE: THICK TUNING ADJUSTMENT FOR L AND BG	0AH
	2CH	BG_FINE: FINE TUNING ADJUSTMENT FOR L AND BG	00H
	2DH	LP_FINE: FINE TUNING ADJUSTMENT FOR L'	00H
	2EH	DELAY SEARCH: XXXXXXX0 -> SHOWS 'PROGRAMME -' DURING AUTOSEARCH. XXXXXXX1 -> DHOWS 'AUTO SEARCH' DURING AUTOSEARCH	00H
	2FH	VHF1_SP: STEP FOR AUTO SEARCH IN VHF1 BAND	0AH
	30H	VHF3_SP: STEP FOR AUTO SEARCH IN VHF3 BAND	05H
	31H	UHF_SP: STEP FOR AUTO SEARCH IN VHF BAND	03H
	32H	OLD_PROGRAM: FOR FLASHBACK RETURN	02H
	33H	UHFHIGH: UPPER WINDOW LIMIT FOR UHF	01H
	34H	VHF3HIGH: UPPER WINDOW LIMIT FOR VHF3	01H
	35H	VHF1HIGH: UPPER WINDOW LIMIT FOR VHF1	01H
	36H	PRG_NUMBER: CURRENT PROGRAMME NUMBER	03H
	37H	WAITSUP: UPPER LIMIT DELAY TIME FOR AUTOSEARCH.	0FH
	38H	WAITINF: LOWER LIMIT DELAY TIME FOR AUTOSEARCH	03H
	3BH	SCART BLOKING: - 00H = NO SCARTBLOCKING - 01H = SCART BLOCKING WHEN ANY PR. IS IN CHILD LOCK MODE.	00H <i>Do not use. Just for UK models</i>
	3CH	RET_COL: DELAY IN COLOUR IDENTIFICATION IN AUTO MODE.	40H
	3FH	CHECKSUM	7EH

●PIF/AGC Adjustment

1. B/G AFT Adjustment

1. Connect the output of SSG (Standard Signal Generator) to the tuner IF output terminal.
 - SSG output 38.9 MHz (CW) \pm 5 KHz.
 - SSG output level: approx. 90 dB μ V.
2. Enter into Service Mode.
3. Push «2» key on R/C. «FI OK» will appear.
4. Switch set OFF and ON again, setting is now memorized.

2. RF-AGC STR Adjustment

1. Receive the «COLOUR BAR» signal (Channel E-12). Signal strength: 57 dB μ V.
2. Enter into Service Mode.
3. Push CH until AGC STR appears on screen.
4. Push «7» key of R/C.«AGC OK» will appear.
5. Switch set OFF and ON again, setting is now memorized.

●Screen Adjustment

3. Focus Adjustment

1. Apply mains voltage of 220V AC/50HZ to TV.
2. Receive Philips pattern signal to a level between 60 and 80 dB μ V.
3. Set contrast to 10/10, brightness to 5/10 and colour 0/10.
4. Adjust focus potentiometer to obtain maximum definition.

4. G2 Adjustment

1. Apply mains voltage of 220V AC/50HZ to TV.
2. Receive cross hatch pattern signal to a level between 60 and 80 dB μ V.
3. Apply High Voltage Probe to Pin 8 of CRT socket
4. Adjust G2 potentiometer until obtaining 525V \pm 10%.
5. Check BKGD. If it is necessary adjust BKGD according to instructions detailed in the next page.

•GEOMETRY ADJUSTMENT PROCEDURE

1. HOR POS

- a) Receive Philips pattern signal.
- b) When $\triangleleft \wedge$ button is pressed, picture moves to the left.
- c) When $\vee \triangleleft$ button is pressed, picture moves to the right.
- d) Adjust the horizontal location to obtain picture centering (Fig.1).

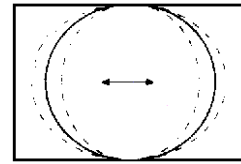

Fig. 1

2. VERT POS

- a) Receive Philips pattern signal.
- b) When $\triangleleft \wedge$ button is pressed, picture moves up.
- c) When $\vee \triangleleft$ button is pressed, picture moves down.
- d) Adjust the vertical location to obtain picture centering (Fig.2).

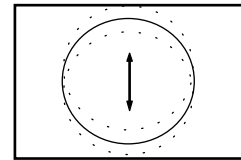

Fig. 2

3. VERT AM

- a) Receive Philips pattern signal.
- b) When $\triangleleft \wedge$ button is pressed, vertical size of picture increases.
- c) When $\vee \triangleleft$ button is pressed, vertical size of picture decreases.
- d) Adjust the vertical size to obtain picture overscan (Fig.3).

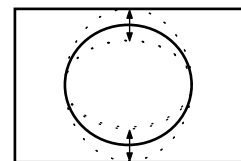

Fig. 3

•COLOUR ADJUSTMENT (BKGD) PROCEDURES

The following adjustments are required when the Picture Tube or IC801 are replaced, or may be necessary after adjustment of the G2 voltage.

1. «B-GAIN», «G-GAIN»

- a) Adjust G2.
- b) Tune a grey scale pattern.
- c) Adjust colour to minimum.
- d) Fix R-GAIN value to 50.
- e) Position colourmeter in the the left point of Fig.4.
- f) Using brightness and contrast buttons, select a luminance of ≈ 120 nits.
- g) Operate again in Service Mode and select location B-GAIN and G-GAIN to obtain colour coordinates:

$$X = 0.290 \pm 0.015$$

$$Y = 0.300 \pm 0.015$$

- h) Exit Service Mode and check colour coordinates «X» and «Y» at 20 and 120 nits. It may be necessary to repeat the same procedure or re-adjust the cuts as show the be below one.

2. «G-DC», «R-DC»

- a) Adjust G2, in the case that it has not been made previously.
- b) Tune a grey scale pattern.
- c) Adjust colour to minimum.
- e) Position colourmter in the the right point of Fig.4.
- f) Using brightness and contrast buttons, select a luminance of ≈ 20 nits.
- g) Operate again in Service Mode and select location G-DC and R-DC to obtain colour coordinates:

$$X = 0.290 \pm 0.015$$

$$Y = 0.300 \pm 0.015$$

- h) Exit Service Mode and check colour coordinates «X» and «Y» at 20 and 120 nits. It may be necessary to repeat the same procedure or the previous one.

NOTE: Locations «R» alter «X» coordinates; «G» alter «Y» coordinates; «B» alter «X» and «Y» coordinates.

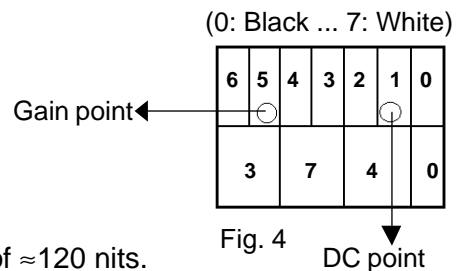
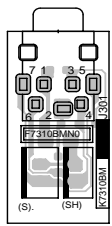
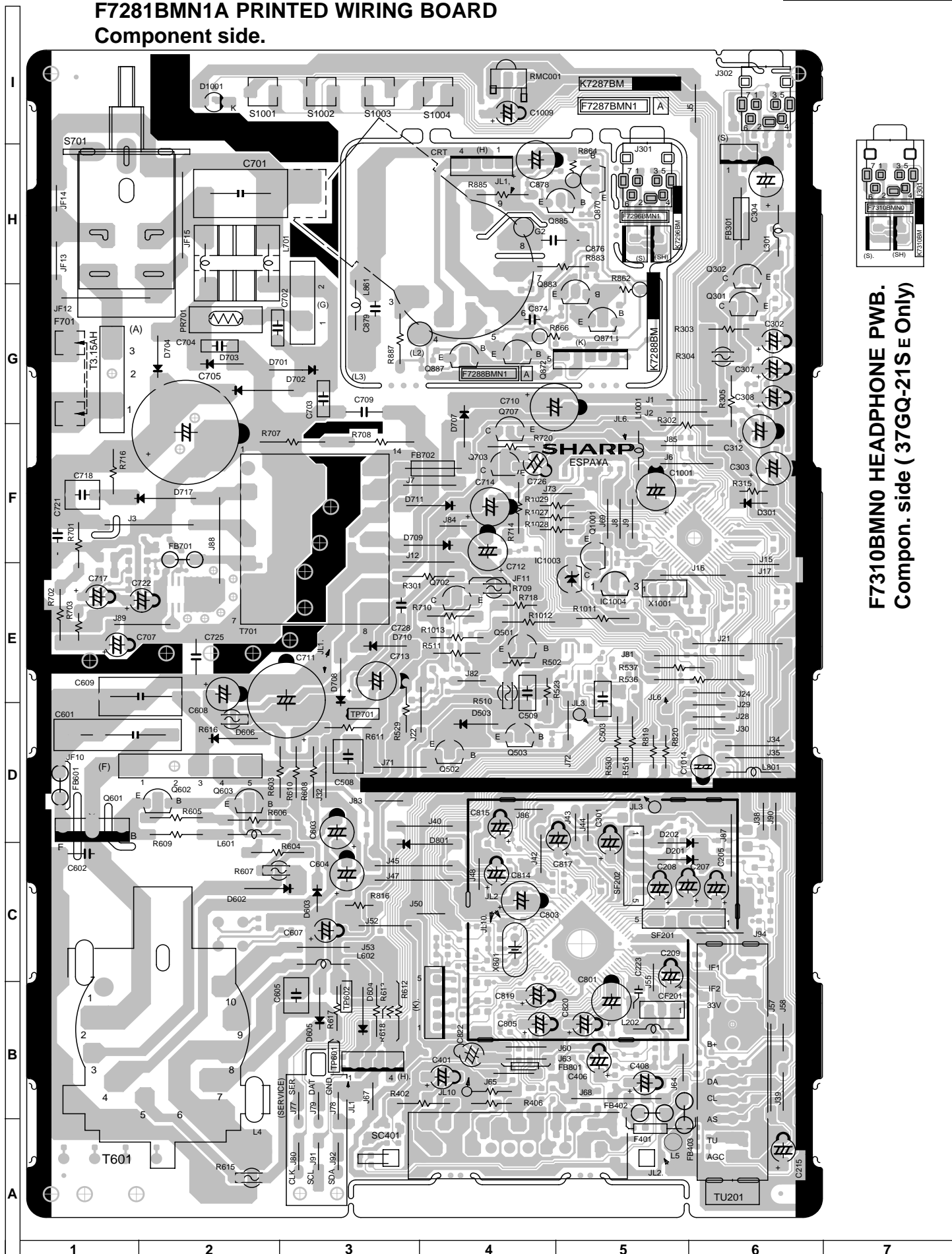

Fig. 4

F7281BMN1A PRINTED WIRING BOARD
Component side.



F7310BMN0 HEADPHONE PWB.
Component side (37GQ-21S E Only)

F7281BMN1A PRINTED WIRING BOARD

Copper side.

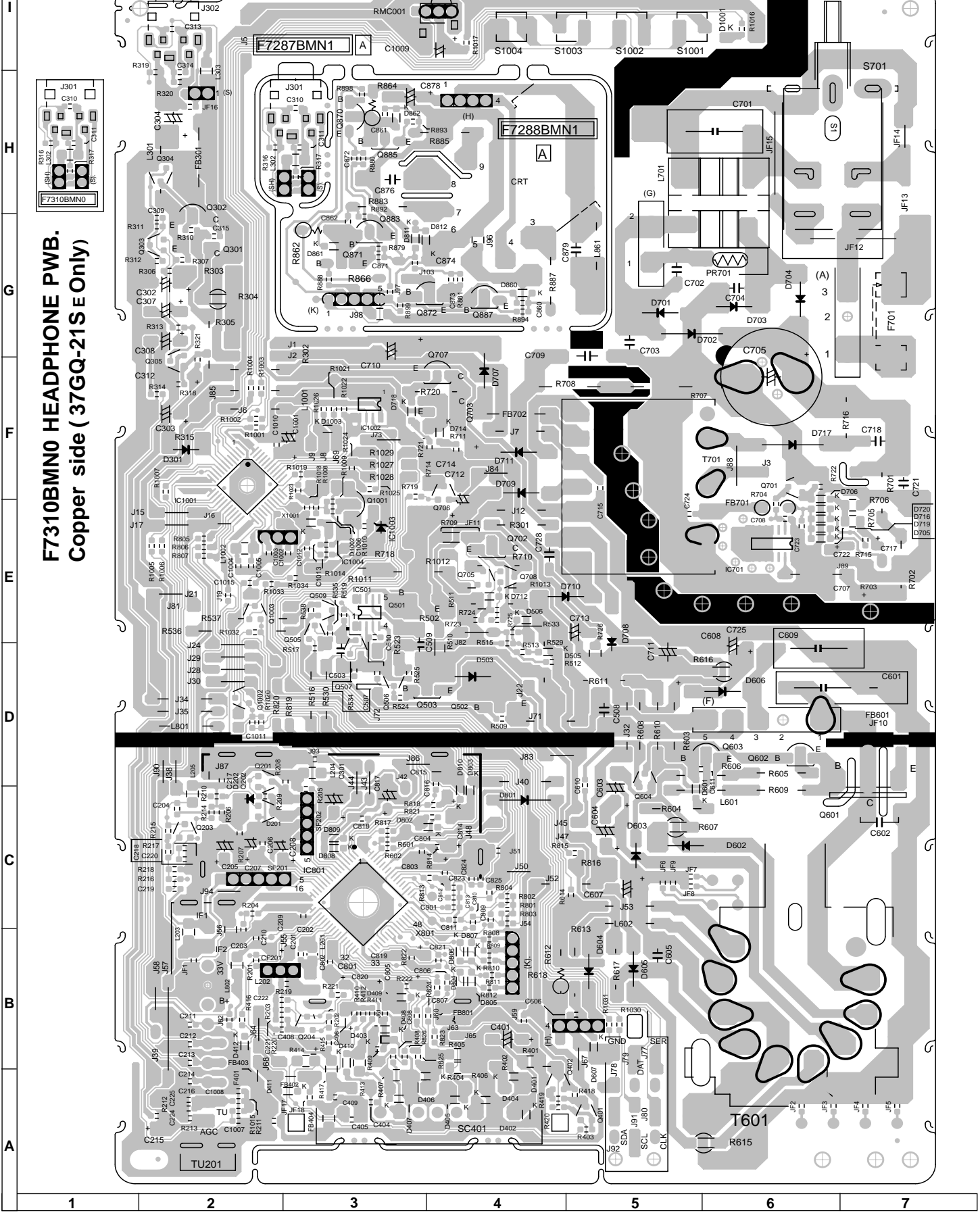

F7310BMNO HEADPHONE PWB.
Copper side (37GQ-21SE Only)

DESCRIPTION OF SCHEMATIC DIAGRAM

SAFETY NOTE:

1. DISCONNECT THE AC PLUG FROM THE AC OUTLET BEFORE REPLACING PARTS.

2. SEMICONDUCTOR HEAT SINKS SHOULD BE REGARDED AS POTENTIAL SHOCK HAZARDS WHEN THE CHASSIS IS OPERATING.

IMPOTANT SAFETY NOTE:

PARTS MARKED WITH « Δ » () ARE IMPORTANT FOR MAINTAINING THE SAFETY OF THE SET. BE SURE TO REPLACE THESE PARTS WITH SPECIFIED ONES FOR MAINTAINING THE SAFETY AND PERFORMANCE OF THE SET.

NOTE:

1. The unit of resistance «ohm» is omitted (K=1000 ohms. M= Megaohm).
2. All resistors are 1/8 watt. unless otherwise noted.
3. All capacitors are μF , unless otherwise noted (P= $\mu\mu\text{F}$).
4. The capacitor with Part No. RC-FZ9XXXBMNJ is designed to with stand 63V.

SERVICE PRECAUTION:

THE AREA ENCLOSED BY THIS LINE (---) IS DIRECTLY CONNECTED WITH AC MAINS VOLTAGE.

WHEN SERVICING THE AREA, CONNECT AN ISOLATING TRANSFORMER BETWEEN TV RECEIVER AND AC LINE TO ELIMINATE HAZARD OF ELECTRIC SHOCK.

CAUTION

This circuit diagram is original one, therefore there may be slight difference from yours.

WAVEFORM MEASUREMENT CONDITION:

Colour bar genetator signal of 70 dB from RF input.

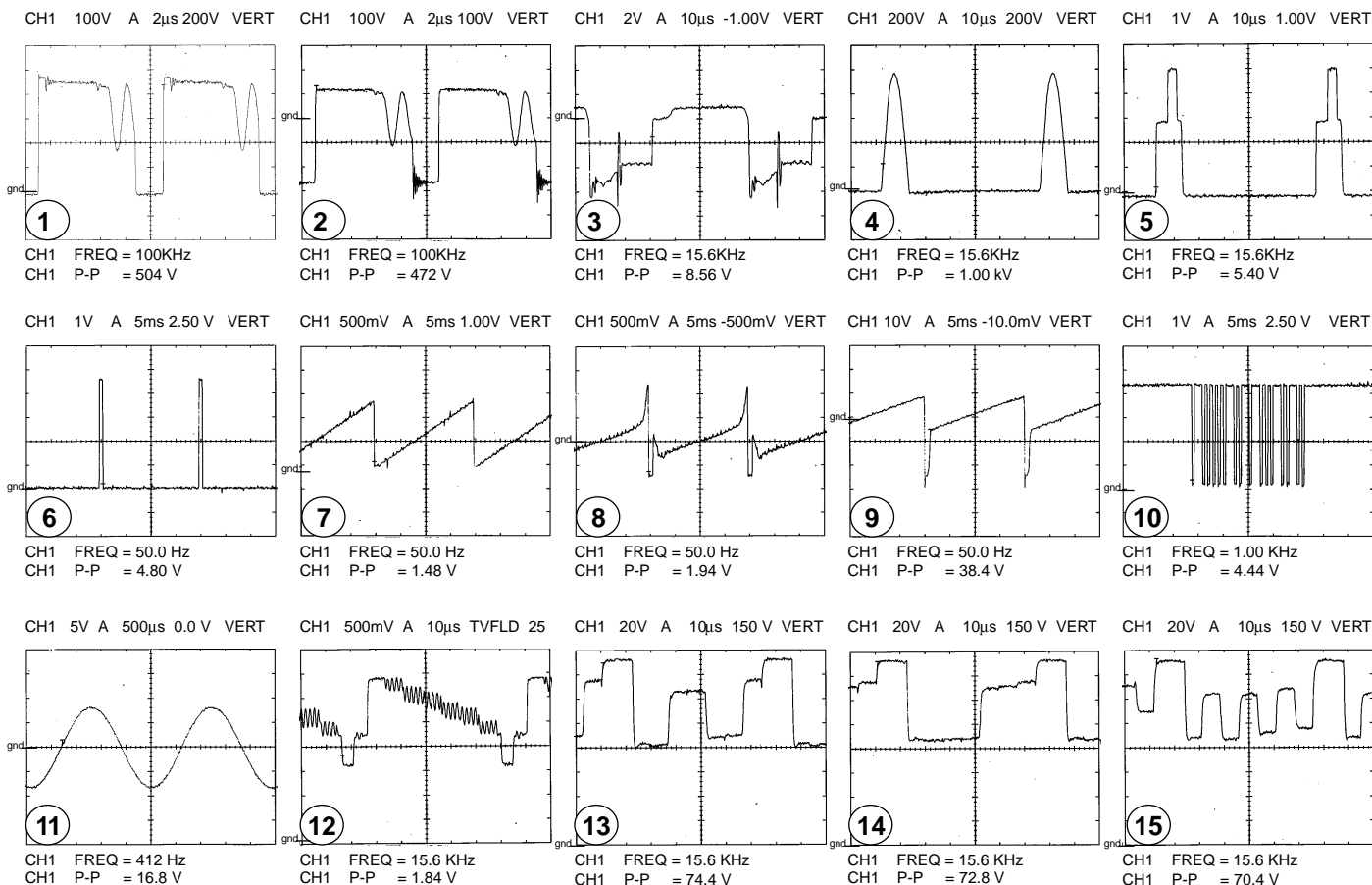

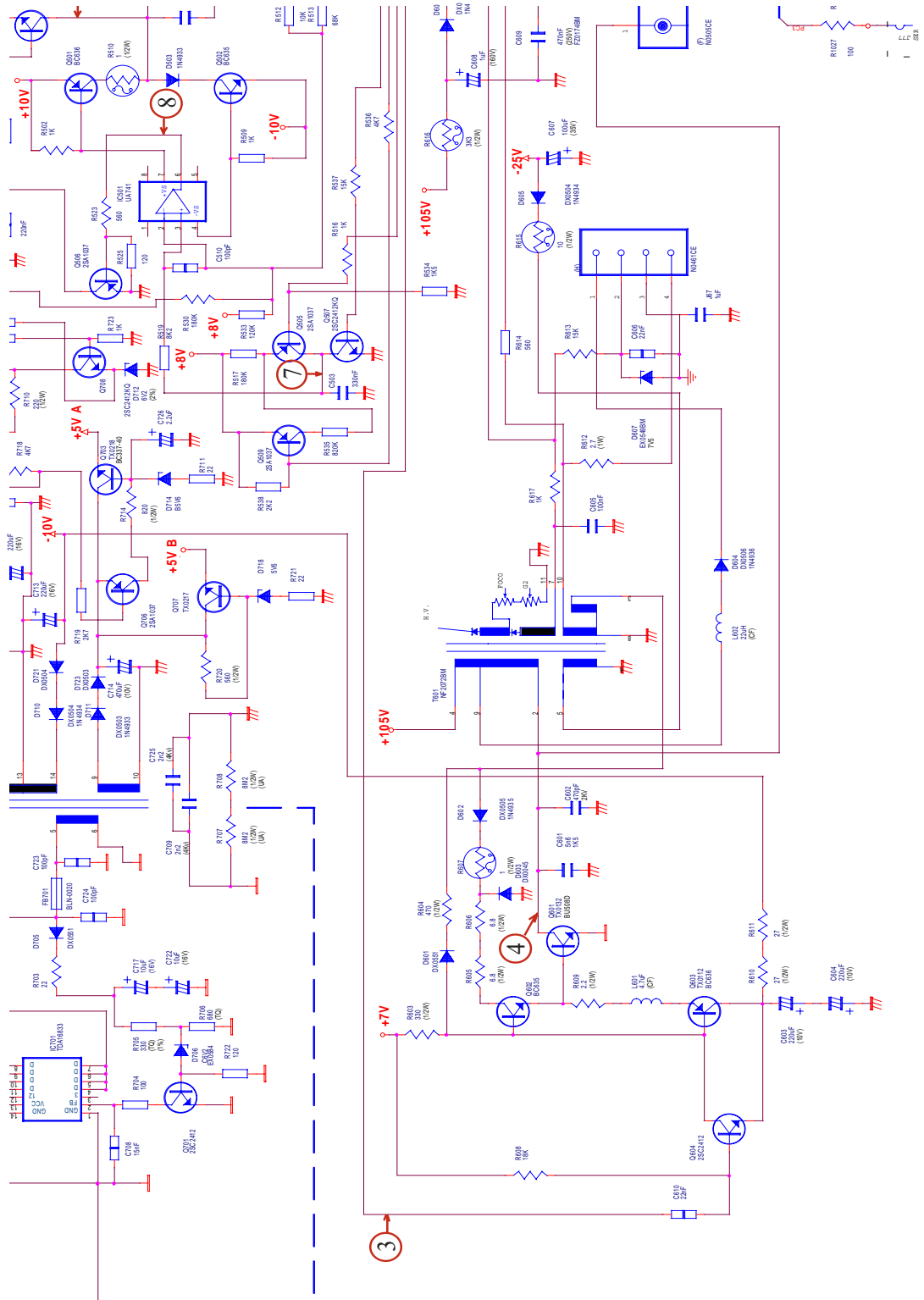

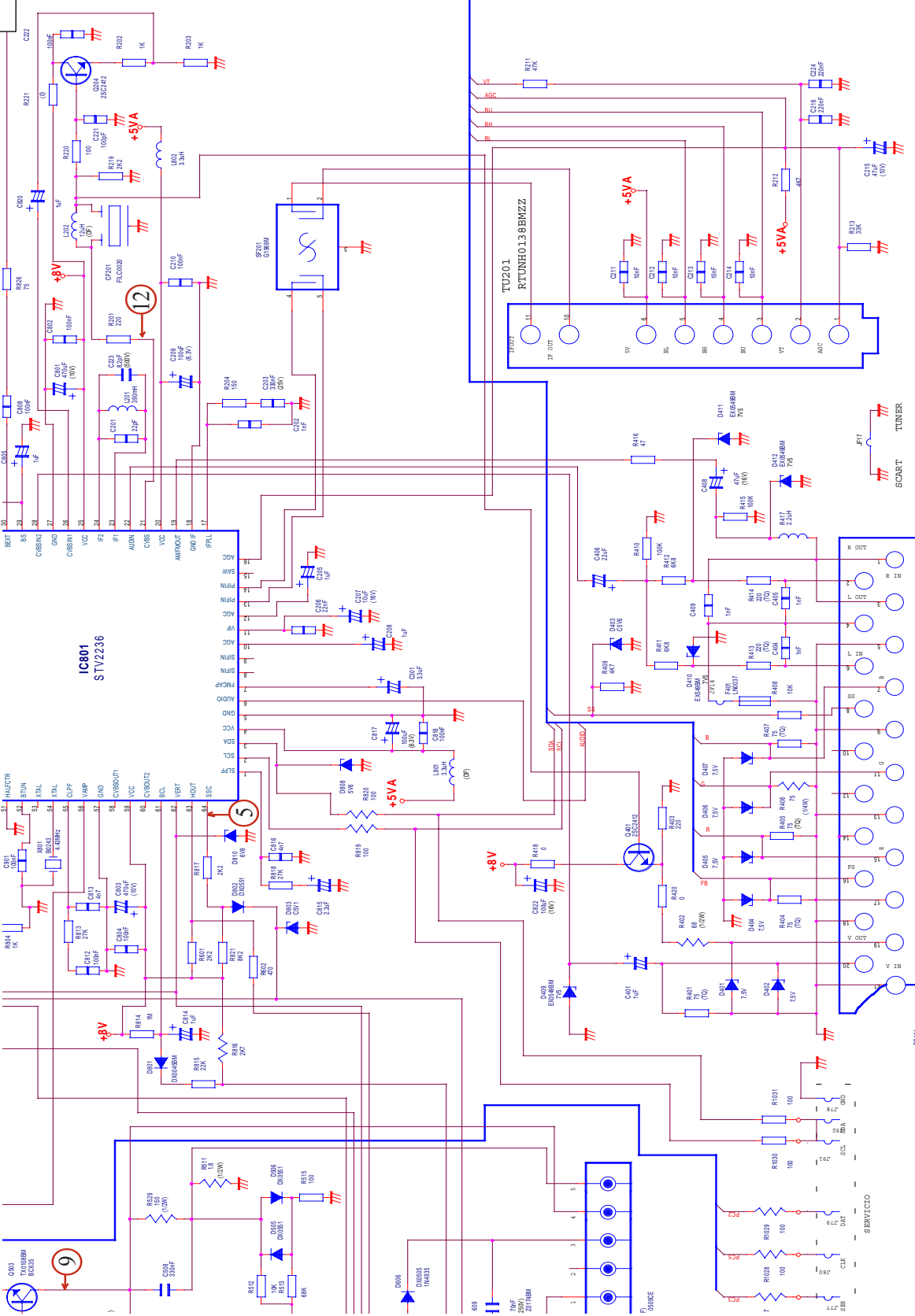

6	07-03-2010	MOD.: HASPA No.79	SHARP <small>ELECTRONIC SYSTEM S.A.</small>	Q I T P 7 2 8 7 B M N *	1.1
5	24-02-2010	MOD.: HASPA No.76			
4	11-02-2010	MOD.: HASPA No.59			
3	10-02-2010	MOD.: HASPA No.57			
2	14-03-2010	MOD.: HASPA No.79			
1	08-03-2010	MOD.: HASPA No. 81			
REALIZADO VERIFICADO APROBADO		SQUAD	SHARP		
DATE:		08-03-2000	37GQ-20S/21S		
DATE:		DATE:	DATE:		

PART LIST

REPLACEMENT PARTS

Replacement parts which have special safety characteristics are identified in this manual. Electrical components having such features are identified by Δ in the Replacement Part List.

The use of a substitute replacement part which does not have the same safety characteristics as the factory recommended is not permitted. Replacement parts not shown in this service manual may create shock fire, or other hazards.

HOW TO ORDER REPLACEMENT PARTS

To have your order completed promptly and correctly please supply the following information.

1. MODEL NUMBER
2. REF. NO.
3. PART NO.
4. DESCRIPTION
5. CODE
6. QUANTITY

MARK *: SPARE PARTS DELIVERY SECTION

REF No.	PARTS	DESCRIPTION	* SN CODE	EX CODE
PICTURE TUBE				
Δ	VB34EAC0136*N	CRT 14" A34EAC01X36	S BH	BZ
Δ	RCILG0415BMZZ	Degaussing Coil 14"	S AF	AM
PRINTED WIRING BOARDS (Not replacement item)				
PWB-A	DUNT7287CJV0	ADJUST CHASSIS 37GQ20SDE-DES/IT/NL/SE	--	--
PWB-B	DUNT7288CJV0	ADJUST TRC UNIT 37GQ20SDE-DES/IT/NL/SE	--	--
PWB-C	DUNT7310BMV0	HEADPHONE INS CHIP 37GQ21S ONLY	S AD	AL
	DSETU7287CJV0	ADJUST MOTHER SET 37GQ20SDE/SDES	S BE	BV
PWB-A MOTHER UNIT				
TUNER				
TU 0201	RTUNH0138BMZZ	TUNER VST CTT 5045 THOMSON HYP	S AL	AX
INTEGRATED CIRCUITS				
IC 0501	RH-IX1783BMZZ	IC UA741CDR TEXAS INSTRUMENTS	S AA	AD
IC 0701	RH-IX1782BMZZ	IC TDA16833 SIEMENS	S AD	AL
IC 0801	RH-IX1792BMZZ	IC STV2236 SGS-THOMSON -PAL	S AM	AX
IC 1001	RH-IX1780BMZZ	IC ST6387 SGS-THOMSON	S AQ	BB
IC 1003	RH-IX0037CEZ1	IC UPC574J 33V NEC	S AF	AD
IC 1004	VHIPST529C2-1	IC PST529C2 MITSUMI	S AD	AD
TRANSISTORS				
Q 0204	VS2SC2412KQ-1	TRT 2SC2412 ROHM	S AA	AA
Q 0301	RH-TX0217BMZZ	TRT BC337 PHILIPS	S AA	AB
Q 0302	RH-TX0216BMZZ	TRT BC327	S AA	AA
Q 0303	VS2SA1037KQ-1	TRT BC807 SMD	S AA	AA
Q 0304	VS2SC2412KQ-1	TRT 2SC2412 ROHM	S AA	AA
Q 0305	VS2SC2412KQ-1	TRT 2SC2412 ROHM	S AA	AA
Q 0401	VS2SC2412KQ-1	TRT 2SC2412 ROHM	S AA	AA
Q 0501	RH-TX0112BMZZ	TRT BC636	S AA	AB
Q 0502	RH-TX0108BMZZ	TRT BC635	S AA	AC
Q 0503	RH-TX0108BMZZ	TRT BC635	S AA	AC
Q 0505	VS2SA1037KQ-1	TRT BC807 SMD	S AA	AA
Q 0506	VS2SA1037KQ-1	TRT BC807 SMD	S AA	AA
Q 0507	VS2SC2412KQ-1	TRT 2SC2412 ROHM	S AA	AA
Q 0509	VS2SA1037KQ-1	TRT BC807 SMD	S AA	AA
Q 0601	RH-TX0132BMZZ	TRT BU508DF1	S AF	AM
Q 0602	RH-TX0108BMZZ	TRT BC635	S AA	AC
Q 0603	RH-TX0112BMZZ	TRT BC636	S AA	AB
Q 0604	VS2SC2412KQ-1	TRT 2SC2412 ROHM	S AA	AA
Q 0701	VS2SC2412KQ-1	TRT 2SC2412 ROHM	S AA	AA
Q 0702	RH-TX0218BMZZ	TRT BC337-40 PHILIPS	S AA	AA
Q 0703	RH-TX0218BMZZ	TRT BC337-40 PHILIPS	S AA	AA
Q 0705	VS2SA1037KQ-1	TRT BC807 SMD	S AA	AA
Q 0706	VS2SA1037KQ-1	TRT BC807 SMD	S AA	AA

REF No.	PARTS	DESCRIPTION	* SN CODE	EX CODE
Q 0707	RH-TX0217BMZZ	TRT BC337 PHILIPS	S AA	AB
Q 0708	VS2SC2412KQ-1	TRT 2SC2412 ROHM	S AA	AA
Q 1001	RH-TX0111BMZZ	TRT PH-2369 PHILIPS	S AA	AB
Q 1002	VS2SC2412KQ-1	TRT 2SC2412 ROHM	S AA	AA
Q 1003	VS2SA1037KQ-1	TRT BC807 SMD	S AA	AA
DIODES				
D 0301	RH-DX0045BMZZ	DIODE 1N4148	S AA	AA
D 0401	RH-EX0549BMZZ	ZENER DIODE TZMC7V5 TFK SMD	S AA	AA
D 0402	RH-EX0549BMZZ	ZENER DIODE TZMC7V5 TFK SMD	S AA	AA
D 0403	RH-EX0546BMZZ	ZENER DIODE TZMC5V6 TFK SMD	S AA	AA
D 0404	RH-EX0549BMZZ	ZENER DIODE TZMC7V5 TFK SMD	S AA	AA
D 0405	RH-EX0549BMZZ	ZENER DIODE TZMC7V5 TFK SMD	S AA	AA
D 0406	RH-EX0549BMZZ	ZENER DIODE TZMC7V5 TFK SMD	S AA	AA
D 0407	RH-EX0549BMZZ	ZENER DIODE TZMC7V5 TFK SMD	S AA	AA
D 0409	RH-EX0549BMZZ	ZENER DIODE TZMC7V5 TFK SMD	S AA	AA
D 0410	RH-EX0549BMZZ	ZENER DIODE TZMC7V5 TFK SMD	S AA	AA
D 0411	RH-EX0549BMZZ	ZENER DIODE TZMC7V5 TFK SMD	S AA	AA
D 0412	RH-EX0549BMZZ	ZENER DIODE TZMC7V5 TFK SMD	S AA	AA
D 0503	RH-DX0503BMZZ	DIODE 1N4933	S AB	AB
D 0505	RH-DX0551BMZZ	DIODE LL4148 TFK SMD	S AA	AA
D 0506	RH-DX0551BMZZ	DIODE LL4148 TFK SMD	S AA	AA
D 0601	RH-DX0551BMZZ	DIODE LL4148 TFK SMD	S AA	AA
D 0602	RH-DX0505BMZZ	DIODE 1N4935	S AB	AE
D 0603	RH-DX0045BMZZ	DIODE 1N4148	S AA	AA
D 0604	RH-DX0506BMZZ	DIODE 1N4936	S AB	AB
D 0605	RH-DX0504BMZZ	DIODE 1N4934	S AB	AB
D 0606	RH-DX0505BMZZ	DIODE 1N4935	S AB	AE
D 0607	RH-EX0549BMZZ	ZENER DIODE TZMC7V5 TFK SMD	S AA	AA
D 0701	RH-DX0571BMZZ	DIODE 1N4005 ACPA	S AA	AA
D 0702	RH-DX0571BMZZ	DIODE 1N4005 ACPA	S AA	AA
D 0703	RH-DX0571BMZZ	DIODE 1N4005 ACPA	S AA	AA
D 0704	RH-DX0571BMZZ	DIODE 1N4005 ACPA	S AA	AA
D 0705	RH-DX0551BMZZ	DIODE LL4148 TFK SMD	S AA	AA
D 0706	RH-EX0584BMZZ	ZENER DIODE TZMC6V2 TFK SMD 2%	S AA	AA
D 0707	RH-DX0505BMZZ	DIODE 1N4935	S AB	AE
D 0708	RH-DX0561BMZZ	DIODE RGP15J FAGOR	S AC	AD
D 0709	RH-EX0590BMZZ	DIODE MBR1100RL MOTOROLA	S AD	AE
D 0710	RH-DX0504BMZZ	DIODE 1N4934	S AB	AB
D 0711	RH-DX0503BMZZ	DIODE 1N4933	S AB	AB
D 0712	RH-EX0547BMZZ	ZENER DIODE TZMC6V2 TFK SMD	S AA	AA
D 0714	RH-EX0546BMZZ	ZENER DIODE TZMC5V6 TFK SMD	S AA	AA
D 0716	RH-DX0551BMZZ	DIODE LL4148 TFK SMD	S AA	AA
D 0717	RH-DX0507BMZZ	DIODE 1N4937	S AA	AB
D 0718	RH-EX0546BMZZ	ZENER DIODE TZMC5V6 TFK SMD	S AA	AA
D 0721	RH-DX0504BMZZ	DIODE 1N4934	S AB	AB
D 0722	RH-DX0504BMZZ	DIODE 1N4934	S AB	AB
D 0723	RH-DX0503BMZZ	DIODE 1N4933	S AB	AB
D 0801	RH-DX0045BMZZ	DIODE 1N4148	S AA	AA
D 0802	RH-DX0551BMZZ	DIODE LL4148 TFK SMD	S AA	AA
D 0803	RH-EX0545BMZZ	ZENER DIODE TZMC5V1 TFK SMD	S AA	AA
D 0804	RH-EX0546BMZZ	ZENER DIODE TZMC5V6 TFK SMD	S AA	AA
D 0805	RH-EX0546BMZZ	ZENER DIODE TZMC5V6 TFK SMD	S AA	AA
D 0806	RH-EX0546BMZZ	ZENER DIODE TZMC5V6 TFK SMD	S AA	AA
D 0807	RH-EX0546BMZZ	ZENER DIODE TZMC5V6 TFK SMD	S AA	AA
D 0808	RH-EX0546BMZZ	ZENER DIODE TZMC5V6 TFK SMD	S AA	AA
D 0810	RH-EX0548BMZZ	ZENER DIODE TZMC6V8 TFK SMD	S AA	AA
D 1001	RH-PX0104BMZZ	LED ROJO	S AB	AC
D 1002	RH-EX0546BMZZ	ZENER DIODE TZMC5V6 TFK SMD	S AA	AA
PACKAGED CIRCUITS				
PR 0701	RMPTP0028CEZZ	PTC RESISTOR	S AA	AE
X 0801	RCRSB0243BMZZ	CRYSTAL 473.000.6835 (4.43 MHZ) ACAL	S AA	AE
COILS				
L 0201	RCILP0227BMZZ	COIL SMD 390NH LQN1HR39J	S AC	AE
L 0202	VP-DF120K0000	PEAK COIL 12UH 10%	S AA	AA
L 0301	VP-DF3R3K0000	PEAK COIL 3,3UH 10%	S AB	AB

REF No.	PARTS	DESCRIPTION	* SN CODE	EX CODE
L 0601	VP-CF47R7K0000	PEAK COIL 4,7UH 10%	S AB	AB
L 0602	VP-CF220K0000	PEAK COIL 22UH 10%	S AA	AA
L 0701	RCILF0160BMZZ	AC.FILTER 30MH MURATA	S AB	AF
L 0801	VP-DF3R3K0000	PEAK COIL 3,3UH 10%	S AB	AB
L 0802	VP-NM3R3MR19N	COIL 3,3UH SMD	S AA	AC
L 1001	VP-DF100K0000	PEAK COIL 10UH 10%	S AA	AA
L 1002	VP-NM680K3R5N	COIL 68UH SMD	S AA	AD
CERAMIC FILTERS				
SF 0201	RFILC0111BMZZ	SAW FILTER G1968M	S AF	AM
X 1001	RFILC0121GEZZ	FILTER CST8.00MTW MURATA	S AC	AD
TRANSFORMERS				
△ T 0601	RTRNF2072BMZZ	SMT 8228 001 3493 PHILIPS 14"	S AK	AW
△ T 0701	RTRNZ0580BMZZ	SMT 8228 001 3500 PHILIPS 14"	S AD	AL
CAPACITORS				
C 0201	VCCCTV1HH220J	CERAM C 22PF 50V 2125SMD	S AA	AA
C 0202	VCKYTV1HB102K	CERAM C 1NF 50V 2125SMD	S AA	AA
C 0203	VCKYTV1EF334Z	CERAM C 330NF 25V 2125SMD	S AA	AB
C 0205	VCEAGA1HW105M	ELEC C 1UF 20% 50V	S AA	AA
C 0206	VCKYTV1HF223Z	CERAM C 22NF 50V 2125SMD	S AA	AA
C 0207	VCEAGA1CW106M	ELEC C 10UF 20% 16V	S AA	AA
C 0208	VCEAGA1HW105M	ELEC C 1UF 20% 50V	S AA	AA
C 0209	VCEAGA0JW107M	ELEC C 100UF 20% 6,3V	S AA	AA
C 0210	VCKYTV1HF104Z	CERAM C 100NF 50V 2125SMD	S AA	AA
C 0211	VCKYTV1HF103Z	CERAM C 10NF 50V 2125SMD	S AA	AA
C 0212	VCKYTV1HF103Z	CERAM C 10NF 50V 2125SMD	S AA	AA
C 0213	VCKYTV1HF103Z	CERAM C 10NF 50V 2125SMD	S AA	AA
C 0214	VCKYTV1HF103Z	CERAM C 10NF 50V 2125SMD	S AA	AA
C 0215	VCEAGA1AW476M	ELEC C 47UF 20% 10V	S AA	AA
C 0216	VCKYTV1HF224Z	CERAM C 220NF 50V 2125SMD	S AA	AB
C 0221	VCCCTV1HH101J	CERAM C 100PF 50V 2125SMD	S AA	AA
C 0222	VCKYTV1HF104Z	CERAM C 100NF 50V 2125SMD	S AA	AA
C 0223	VCCWPA2HL8R2C	C 8,2PF 0,25 N1500 500V	S AA	AB
C 0224	VCKYTV1HB104K	CERAM C 100NF 50V 2125SMD	S AA	AA
C 0225	VCKYTV1HB104K	CERAM C 100NF 50V 2125SMD	S AA	AA
C 0301	VCEAGA1HW225M	ELEC C 2,2UF 20% 50V	S AA	AB
C 0302	VCEAGA1HW105M	ELEC C 1UF 20% 50V	S AA	AA
C 0303	VCEAGA2CW105M	ELEC C 1UF 20% 160V	S AA	AB
C 0304	VCEAGA1CW107M	ELEC C 100UF 20% 16V	S AA	AA
C 0307	VCEAGA1CW476M	ELEC C 47UF 20% 16V	S AA	AA
C 0308	VCEAGA1HW105M	ELEC C 1UF 20% 50V	S AA	AA
C 0309	VCKYTV1HF103Z	CERAM C 10NF 50V 2125SMD	S AA	AA
C 0312	VCEAGA1AW227M	ELEC C 220UF 20% 10V	S AA	AA
C 0315	VCCCTV1HH101J	CERAM C 100PF 50V 2125SMD	S AA	AA
C 0401	VCEAGA1HW105M	ELEC C 1UF 20% 50V	S AA	AA
C 0404	VCKYTV1HB102K	CERAM C 1NF 50V 2125SMD	S AA	AA
C 0405	VCKYTV1HB102K	CERAM C 1NF 50V 2125SMD	S AA	AA
C 0406	VCEAGA1HW226M	ELEC C 22UF 20% 50V	S AA	AA
C 0408	VCEAGA1CW476M	ELEC C 47UF 20% 16V	S AA	AA
C 0409	VCKYTV1HB102K	CERAM C 1NF 50V 2125SMD	S AA	AA
C 0503	RC-FZ9334BMNJ	POL FILM C 330NF 5% 63V	S AA	AC
C 0507	VCKYTV1HF224Z	CERAM C 220NF 50V 2125SMD	S AA	AB
C 0508	RC-FZ9334BMNJ	POL FILM C 330NF 5% 63V	S AA	AC
C 0510	VCCCTV1HH101J	CERAM C 100PF 50V 2125SMD	S AA	AA
C 0601	RC-FZ0135BMZZ	POLIP C B32650 6N8 1,5KV	S AB	AE
C 0603	VCEAGA1AW227M	ELEC C 220UF 20% 10V	S AA	AA
C 0604	VCEAGA1AW227M	ELEC C 220UF 20% 10V	S AA	AA
C 0605	RC-FZ9104BMNJ	POL FILM C 100NF 5% 63V	S AA	AB
C 0606	VCKYTV1HF223Z	CERAM C 22NF 50V 2125SMD	S AA	AA
C 0607	VCEAGA1VW107M	ELEC C 100UF 20% 35V	S AA	AA
C 0608	VCEAGA2CW105M	ELEC C 1UF 20% 160V	S AA	AB
C 0609	RC-FZ0174BMZZ	POLIP C B32652 470NF 250V	S AA	AC
C 0610	VCKYTV1HB223K	CERAM C 22NF 50V 2125SMD	S AA	AA
△ C 0701	RC-FZ0160BMZZ	CAP B1133-D1474-M SIEMENS	S AC	AF
C 0702	RC-KZ0029CEZZ	CERAM C 10NF 80,20% 250V	S AC	AC

REF No.	PARTS	DESCRIPTION	* SN CODE	EX CODE
C 0703	RC-KZ0029CEZZ	CERAM C 10NF 80,20% 250V	S AC	AC
C 0704	RC-KZ0029CEZZ	CERAM C 10NF 80,20% 250V	S AC	AC
C 0705	RC-EZ0140BMZZ	ELEC C 47UF 400V TROBO	S AC	AK
C 0707	VCEAGA1CW106M	ELEC C 10UF 20% 16V	S AA	AA
C 0708	VCKYTV1HB153K	CERAM C 15NF 50V 2125SMD	S AA	AA
△ C 0709	RC-KZ0160BMZZ	CERAM C 2,2NF 4KV X1Y1	S AA	AC
C 0710	VCEAGA1EW227M	ELEC C 220UF 20% 25V	S AA	AA
C 0711	VCEAGH2CW107M	ELEC C 100MF 20% 160V	S AA	AE
C 0712	VCEAGA1CW227M	ELEC C 220UF 20% 16V	S AA	AA
C 0713	VCEAGA1CW227M	ELEC C 220UF 20% 16V	S AA	AA
C 0714	VCEAGA1AW477M	ELEC C 470UF 20% 10V	S AA	AB
C 0715	VCKYTV1HF104Z	CERAM C 100NF 50V 2125SMD	S AA	AA
C 0717	VCEAGA1CW106M	ELEC C 10UF 20% 16V	S AA	AA
C 0718	RC-FZ0156BMZZ	C B32529-B6473K SIEMENS	S AD	AE
C 0722	VCEAGA1CW106M	ELEC C 10UF 20% 16V	S AA	AA
C 0723	VCCCTV1HH101J	CERAM C 100PF 50V 2125SMD	S AA	AA
C 0724	VCCCTV1HH101J	CERAM C 100PF 50V 2125SMD	S AA	AA
C 0725	RC-KZ0160BMZZ	CERAM C 2,2NF 4KV X1Y1	S AA	AC
C 0726	VCEAGA1HW225M	ELEC C 2,2UF 20% 50V	S AA	AB
C 0728	RC-KZ0035CEZZ	CERAM C 220PF 2KV	S AA	AC
C 0801	VCEAGA1AW477M	ELEC C 470UF 20% 10V	S AA	AB
C 0802	VCKYTV1HF104Z	CERAM C 100NF 50V 2125SMD	S AA	AA
C 0803	VCEAGA1AW477M	ELEC C 470UF 20% 10V	S AA	AB
C 0804	VCKYTV1HF104Z	CERAM C 100NF 50V 2125SMD	S AA	AA
C 0805	VCEAGA1HW105M	ELEC C 1UF 20% 50V	S AA	AA
C 0806	VCKYTV1HF104Z	CERAM C 100NF 50V 2125SMD	S AA	AA
C 0807	VCKYTV1HF104Z	CERAM C 100NF 50V 2125SMD	S AA	AA
C 0808	VCKYTV1HF104Z	CERAM C 100NF 50V 2125SMD	S AA	AA
C 0809	VCKYTV1HF104Z	CERAM C 100NF 50V 2125SMD	S AA	AA
C 0810	VCKYTV1HF104Z	CERAM C 100NF 50V 2125SMD	S AA	AA
C 0811	VCKYTV1HF104Z	CERAM C 100NF 50V 2125SMD	S AA	AA
C 0812	VCKYTV1HF104Z	CERAM C 100NF 50V 2125SMD	S AA	AA
C 0813	VCKYTV1HB472K	CERAM C 4,7NF 50V 2125SMD	S AA	AA
C 0814	VCEAGA1HW105M	ELEC C 1UF 20% 50V	S AA	AA
C 0815	VCEAGA1HW225M	ELEC C 2,2UF 20% 50V	S AA	AB
C 0816	VCKYTV1HB472K	CERAM C 4,7NF 50V 2125SMD	S AA	AA
C 0817	VCEAGA0JW107M	ELEC C 100UF 20% 6,3V	S AA	AA
C 0818	VCKYTV1HF104Z	CERAM C 100NF 50V 2125SMD	S AA	AA
C 0819	VCEAGA1HW105M	ELEC C 1UF 20% 50V	S AA	AA
C 0820	VCEAGA1HW105M	ELEC C 1UF 20% 50V	S AA	AA
C 0901	VCKYTV1HF104Z	CERAM C 100NF 50V 2125SMD	S AA	AA
C 1001	VCEAGA0JW477M	ELEC C 470UF 20% 6,3V	S AA	AA
C 1002	VCCCTV1HH220J	CERAM C 22PF 50V 2125SMD	S AA	AA
C 1003	VCCCTV1HH220J	CERAM C 22PF 50V 2125SMD	S AA	AA
C 1004	VCCCTV1HH150J	CERAM C 15PF 50V 2125SMD	S AA	AA
C 1005	VCCCTV1HH150J	CERAM C 15PF 50V 2125SMD	S AA	AA
C 1006	VCCCTV1HH220J	CERAM C 22NF 50V 2125SMD	S AA	AA
C 1007	VCKYTV1HF223Z	CERAM C 22NF 50V 2125SMD	S AA	AA
C 1008	VCKYTV1HF473Z	CERAM C 47NF 50V 2125SMD	S AA	AA
C 1009	VCEAGA1AW476M	ELEC C 47UF 20% 10V	S AA	AA
C 1010	VCKYTV1HF104Z	CERAM C 100NF 50V 2125SMD	S AA	AA
C 1011	VCKYTV1EF224Z	CERAM C 220NF 25V 2125SMD	S AA	AA
C 1012	VCKYTV1HF104Z	CERAM C 100NF 50V 2125SMD	S AA	AA
C 1014	VCEAGA1CW106M	ELEC C 10UF 20% 16V	S AA	AA
C 1015	VCKYTV1EF334Z	CERAM C 330NF 25V 2125SMD	S AA	AB
RESISTORS				
R 0201	VRS-TV1JD221J	2125 220 OHM 5% 1/10W SMD	S AA	AA
R 0202	VRS-TV1JD102J	2125 1KOHM 5% 1/10W SMD	S AA	AA
R 0203	VRS-TV1JD102J	2125 1KOHM 5% 1/10W SMD	S AA	AA
R 0204	VRS-TV1JD151J	2125 150 OHM 5% 1/10W SMD	S AA	AA
R 0211	VRS-TV1JD473J	2125 47KOHM 5% 1/10W SMD	S AA	AA
R 0212	VRS-TV1JD472J	2125 4.7KOHM 5% 1/10W SMD	S AA	AA
R 0213	VRS-TV1JD333J	2125 33KOHM 5% 1/10W SMD	S AA	AA
R 0219	VRS-TV1JD222J	2125 2.2KOHM 5% 1/10W SMD	S AA	AA
R 0220	VRS-TV1JD101J	2125 100 OHM 5% 1/10W SMD	S AA	AA
R 0221	VRS-TV1JD000J	2125 0 OHM 5% 1/10W SMD	S AA	AA

	REF No.	PARTS	DESCRIPTION	*	SN CODE	EX CODE
	R 0222	VRS-TV1JD224J	2125 220KOHM 5% 1/10W SMD	S	AA	AA
	R 0301	VRD-RA2HD472J	RES 4.7KOHM 5% 1/2W	S	AA	AA
	R 0302	VRD-RA2HD472J	RES 4.7KOHM 5% 1/2W	S	AA	AA
	R 0303	VRD-RA2BE333J	RES 33KOHM 5% 1/8W	S	AA	AA
△	R 0304	RR-XZ0204BMZZ	FUS RES 2R2 TAP 5% 1/2W	S	AA	AB
	R 0305	VRD-RA2HD472J	RES 4.7KOHM 5% 1/2W	S	AA	AA
	R 0306	VRS-TV1JD104J	2125 100KOHM 5% 1/10W SMD	S	AA	AA
	R 0307	VRS-TV1JD103J	2125 10KOHM 5% 1/10W SMD	S	AA	AA
	R 0310	VRS-TV1JD101J	2125 100 OHM 5% 1/10W SMD	S	AA	AA
	R 0311	VRS-TV1JD104J	2125 100KOHM 5% 1/10W SMD	S	AA	AA
	R 0312	VRS-TV1JD103J	2125 10KOHM 5% 1/10W SMD	S	AA	AA
	R 0313	VRS-TV1JD561J	2125 560 OHM 5% 1/10W SMD	S	AA	AA
	R 0314	VRS-TV1JD102J	2125 1KOHM 5% 1/10W SMD	S	AA	AA
	R 0315	VRD-RA2BE103J	RES 10KOHM 5% 1/8W	S	AA	AA
	R 0318	VRS-TV1JD153J	2125 15KOHM 5% 1/10W SMD	S	AA	AA
	R 0321	VRS-TV1JD102J	2125 1KOHM 5% 1/10W SMD	S	AA	AA
	R 0401	VRS-TQ2BD750J	OX RE 75 OHM 5% 1/8W SMD	S	AA	AA
	R 0402	VRD-RA2HD680J	RES 68 OHM 5% 1/2W	S	AA	AA
	R 0403	VRS-TV1JD221J	2125 220 OHM 5% 1/10W SMD	S	AA	AA
	R 0404	VRS-TQ2BD750J	OX RE 75 OHM 5% 1/8W SMD	S	AA	AA
	R 0405	VRD-RA2EE750J	RES 75 OHM 5% 1/4W	S	AA	AA
	R 0406	VRD-RA2EE750J	RES 75 OHM 5% 1/4W	S	AA	AA
	R 0407	VRS-TQ2BD750J	OX RE 75 OHM 5% 1/8W SMD	S	AA	AA
	R 0408	VRS-TV1JD103J	2125 10KOHM 5% 1/10W SMD	S	AA	AA
	R 0409	VRS-TV1JD223J	2125 22KOHM 5% 1/10W SMD	S	AA	AA
	R 0410	VRS-TV1JD104J	2125 100KOHM 5% 1/10W SMD	S	AA	AA
	R 0411	VRS-TV1JD682J	2125 6.8KOHM 5% 1/10W SMD	S	AA	AA
	R 0412	VRS-TV1JD682J	2125 6.8KOHM 5% 1/10W SMD	S	AA	AA
	R 0413	VRS-TQ2BD221J	OX RE 220 OHM 5% 1/8W SMD	S	AA	AA
	R 0414	VRS-TQ2BD221J	OX RE 220 OHM 5% 1/8W SMD	S	AA	AA
	R 0415	VRS-TV1JD104J	2125 100KOHM 5% 1/10W SMD	S	AA	AA
	R 0416	VRS-TV1JD470J	2125 47 OHM 5% 1/10W SMD	S	AA	AA
	R 0417	VP-NM2R2MR16N	COIL 2.2UH SMD	S	AB	AC
	R 0418	VRS-TV1JD000J	2125 0 OHM 5% 1/10W SMD	S	AA	AA
	R 0420	VRS-TV1JD000J	2125 0 OHM 5% 1/10W SMD	S	AA	AA
	R 0502	VRD-RA2BE102J	RES 1KOHM 5% 1/8W	S	AA	AA
	R 0506	VRD-RA2BE102J	RES 1KOHM 5% 1/8W	S	AA	AA
	R 0509	VRS-TV1JD102J	2125 1KOHM 5% 1/10W SMD	S	AA	AA
△	R 0510	RR-XZ0200BMZZ	FUS RES 1R0 TAP 5% 1/2W	S	AA	AB
	R 0511	VRD-RA2HD1R8J	RES 1.8 OHM 5% 1/2W	S	AA	AA
	R 0512	VRS-TV1JD103J	2125 10KOHM 5% 1/10W SMD	S	AA	AA
	R 0513	VRS-TV1JD683J	2125 68KOHM 5% 1/10W SMD	S	AA	AA
	R 0515	VRS-TV1JD101J	2125 100 OHM 5% 1/10W SMD	S	AA	AA
	R 0517	VRS-TV1JD184J	2125 180KOHM 5% 1/10W SMD	S	AA	AA
	R 0519	VRS-TV1JD822J	2125 8.2KOHM 5% 1/10W SMD	S	AA	AA
	R 0522	VRD-RA2BE104J	RES 100KOHM 5% 1/8W	S	AA	AA
	R 0523	VRD-RA2BE561J	RES 560 OHM 5% 1/8W	S	AA	AA
	R 0524	VRS-TV1JD392J	2125 3.9KOHM 5% 1/10W SMD	S	AA	AA
	R 0525	VRS-TV1JD121J	2125 120 OHM 5% 1/10W SMD	S	AA	AA
	R 0529	VRD-RA2HD151J	RES 150 OHM 5% 1/2W	S	AA	AA
	R 0530	VRD-RA2BE184J	RES 180KOHM 5% 1/8W	S	AA	AA
	R 0533	VRS-TV1JD124J	2125 120KOHM 5% 1/10W SMD	S	AA	AA
	R 0534	VRS-TV1JD152J	2125 1.5KOHM 5% 1/10W SMD	S	AA	AA
	R 0535	VRS-TV1JD824J	2125 820KOHM 5% 1/10W SMD	S	AA	AA
	R 0536	VRD-RA2BE472J	RES 4.7KOHM 5% 1/8W	S	AA	AA
	R 0537	VRD-RA2BE153J	RES 15KOHM 5% 1/8W	S	AA	AA
	R 0538	VRS-TV1JD222J	2125 2.2KOHM 5% 1/10W SMD	S	AA	AA
	R 0601	VRS-TV1JD222J	2125 2.2KOHM 5% 1/10W SMD	S	AA	AA
	R 0602	VRS-TV1JD471J	2125 470 OHM 5% 1/10W SMD	S	AA	AA
	R 0603	VRD-RA2HD331J	RES 330 OHM 5% 1/2W	S	AA	AA
	R 0604	VRD-RA2HD471J	RES 470 OHM 5% 1/2W	S	AA	AA
	R 0605	VRD-RA2HD6R8J	RES 6.8 OHM 5% 1/2W	S	AA	AA
	R 0606	VRD-RA2HD6R8J	RES 6.8 OHM 5% 1/2W	S	AA	AA
△	R 0607	RR-XZ0200BMZZ	FUS RES 1R0 TAP 5% 1/2W	S	AA	AB
	R 0608	VRD-RA2BE183J	RES 18KOHM 5% 1/8W	S	AA	AA
	R 0609	VRD-RA2HD2R2J	RES 2.2 OHM 5% 1/2W	S	AA	AA
	R 0610	VRD-RA2HD270J	RES 27 OHM 5% 1/2W	S	AA	AA

	REF No.	PARTS	DESCRIPTION	*	SN CODE	EX CODE
	R 0611	VRD-RA2HD270J	RES 27 OHM 5% 1/2W	S	AA	AA
	R 0612	VRN-VV3AB2R7J	MET FILM R 2.7 OHM 5% 1W	S	AA	AA
	R 0613	VRD-RA2BE153J	RES 15KOHM 5% 1/8W	S	AA	AA
	R 0614	VRS-TV1JD561J	2125 560 OHM 5% 1/10W SMD	S	AA	AA
△	R 0615	RR-XZ0212BMZZ	FUS RES 10R TAP 5% 1/2W	S	AA	AB
△	R 0616	RR-XZ0242BMZZ	FUS RES 3K3 TAP 5% 1/2W	S	AA	AB
	R 0617	VRD-RA2BE102J	RES 1KOHM 5% 1/8W	S	AA	AA
	R 0701	VRD-RA2HD474J	RES 470KOHM 5% 1/2W	S	AA	AA
	R 0702	VRD-RA2HD474J	RES 470KOHM 5% 1/2W	S	AA	AA
	R 0703	VRD-RA2BE220J	RES 22 OHM 5% 1/8W	S	AA	AA
	R 0704	VRS-TV1JD101J	2125 100 OHM 5% 1/10W SMD	S	AA	AA
	R 0705	VRS-TQ2BD331F	OX RE 330 OHM 1% 1/8W SMD	S	AA	AA
	R 0706	VRS-TQ2BD681J	OX RE 680 OHM 5% 1/8W SMD	S	AA	AA
△	R 0707	VRC-UA2HG825K	SOLID R 8.2MOHM 10% 1/2W	S	AA	AA
△	R 0708	VRC-UA2HG825K	SOLID R 8.2MOHM 10% 1/2W	S	AA	AA
	R 0710	VRD-RA2HD221J	RES 220 OHM 5% 1/2W	S	AA	AA
	R 0711	VRS-TV1JD220J	2125 22 OHM 5% 1/10W SMD	S	AA	AA
	R 0714	VRD-RA2HD821J	RES 820 OHM 5% 1/2W	S	AA	AA
	R 0715	VRS-TV1JD100J	2125 10 OHM 5% 1/10W SMD	S	AA	AA
	R 0716	VRD-RA2HD473J	RES 47KOHM 5% 1/2W	S	AA	AA
	R 0718	VRD-RA2BE472J	RES 4.7KOHM 5% 1/8W	S	AA	AA
	R 0719	VRS-TV1JD272J	2125 2.7KOHM 5% 1/10W SMD	S	AA	AA
	R 0720	VRD-RA2HD561J	RES 560 OHM 5% 1/2W	S	AA	AA
	R 0721	VRS-TV1JD220J	2125 22 OHM 5% 1/10W SMD	S	AA	AA
	R 0722	VRS-TV1JD121J	2125 120 OHM 5% 1/10W SMD	S	AA	AA
	R 0723	VRS-TV1JD102J	2125 1KOHM 5% 1/10W SMD	S	AA	AA
	R 0724	VRS-TV1JD151J	2125 150 OHM 5% 1/10W SMD	S	AA	AA
	R 0725	VRS-TV1JD391J	2125 390 OHM 5% 1/10W SMD	S	AA	AA
	R 0726	VRS-TQ2BD000J	3216 0 OHM 5% 1/8W SMD	S	AA	AA
	R 0801	VRS-TV1JD221J	2125 220 OHM 5% 1/10W SMD	S	AA	AA
	R 0802	VRS-TV1JD221J	2125 220 OHM 5% 1/10W SMD	S	AA	AA
	R 0803	VRS-TV1JD221J	2125 220 OHM 5% 1/10W SMD	S	AA	AA
	R 0804	VRS-TV1JD102J	2125 1KOHM 5% 1/10W SMD	S	AA	AA
	R 0805	VRS-TV1JD102J	2125 1KOHM 5% 1/10W SMD	S	AA	AA
	R 0806	VRS-TV1JD102J	2125 1KOHM 5% 1/10W SMD	S	AA	AA
	R 0807	VRS-TV1JD102J	2125 1KOHM 5% 1/10W SMD	S	AA	AA
	R 0808	VRS-TV1JD102J	2125 1KOHM 5% 1/10W SMD	S	AA	AA
	R 0809	VRS-TV1JD473J	2125 47KOHM 5% 1/10W SMD	S	AA	AA
	R 0810	VRS-TV1JD271J	2125 270 OHM 5% 1/10W SMD	S	AA	AA
	R 0811	VRS-TV1JD271J	2125 270 OHM 5% 1/10W SMD	S	AA	AA
	R 0812	VRS-TV1JD271J	2125 270 OHM 5% 1/10W SMD	S	AA	AA
	R 0813	VRS-TV1JD273J	2125 27KOHM 5% 1/10W SMD	S	AA	AA
	R 0814	VRS-TV1JD105J	2125 1MOHM 5% 1/10W SMD	S	AA	AA
	R 0815	VRS-TV1JD223J	2125 22KOHM 5% 1/10W SMD	S	AA	AA
	R 0816	VRD-RA2BE272J	RES 2.7KOHM 5% 1/8W	S	AA	AA
	R 0817	VRS-TV1JD222J	2125 2.2KOHM 5% 1/10W SMD	S	AA	AA
	R 0818	VRS-TV1JD153J	2125 15KOHM 5% 1/10W SMD	S	AA	AA
	R 0819	VRD-RA2BE101J	RES 100 OHM 5% 1/8W	S	AA	AA
	R 0819	VRS-TV1JD101J	2125 100 OHM 5% 1/10W SMD	S	AA	AA
	R 0820	VRD-RA2BE101J	RES 100 OHM 5% 1/8W	S	AA	AA
	R 0820	VRS-TV1JD101J	2125 100 OHM 5% 1/10W SMD	S	AA	AA
	R 0821	VRS-TV1JD822J	2125 8.2KOHM 5% 1/10W SMD	S	AA	AA
	R 0822	VRS-TV1JD334J	2125 330KOHM 5% 1/10W SMD	S	AA	AA
	R 0823	VRS-TV1JD102J	2125 1KOHM 5% 1/10W SMD	S	AA	AA
	R 0824	VRS-TV1JD750J	2125 75 OHM 5% 1/10W SMD	S	AA	AA
	R 0825	VRS-TV1JD750J	2125 75 OHM 5% 1/10W SMD	S	AA	AA
	R 0826	VRS-TV1JD750J	2125 75 OHM 5% 1/10W SMD	S	AA	AA
	R 1001	VRS-TV1JD101J	2125 100 OHM 5% 1/10W SMD	S	AA	AA
	R 1002	VRS-TV1JD101J	2125 100 OHM 5% 1/10W SMD	S	AA	AA
	R 1003	VRS-TV1JD101J	2125 100 OHM 5% 1/10W SMD	S	AA	AA
	R 1004	VRS-TV1JD101J	2125 100 OHM 5% 1/10W SMD	S	AA	AA
	R 1005	VRS-TV1JD101J	2125 100 OHM 5% 1/10W SMD	S	AA	AA
	R 1006	VRS-TV1JD101J	2125 100 OHM 5% 1/10W SMD	S	AA	AA
	R 1007	VRS-TV1JD101J	2125 100 OHM 5% 1/10W SMD	S	AA	AA
	R 1008	VRS-TV1JD332J	2125 3.3KOHM 5% 1/10W SMD	S	AA	AA
	R 1009	VRS-TV1JD102J	2125 1KOHM 5% 1/10W SMD	S	AA	AA
	R 1010	VRS-TV1JD273J	2125 27KOHM 5% 1/10W SMD	S	AA	AA

REF No.	PARTS	DESCRIPTION	* SN CODE	EX CODE
R 1011	VRD-RA2HD472J	RES 4.7KOHM 5% 1/2W	S AA	AA
R 1012	VRD-RA2HD472J	RES 4.7KOHM 5% 1/2W	S AA	AA
R 1013	VRD-RA2HD472J	RES 4.7KOHM 5% 1/2W	S AA	AA
R 1014	VRS-TV1JD223J	2125 22KOHM 5% 1/10W SMD	S AA	AA
R 1015	VRS-TV1JD223J	2125 22KOHM 5% 1/10W SMD	S AA	AA
R 1016	VRS-TV1JD331J	2125 330 OHM 5% 1/10W SMD	S AA	AA
R 1017	VRS-TV1JD271J	2125 270 OHM 5% 1/10W SMD	S AA	AA
R 1018	VRS-TV1JD103J	2125 10KOHM 5% 1/10W SMD	S AA	AA
R 1019	VRS-TV1JD102J	2125 1KOHM 5% 1/10W SMD	S AA	AA
R 1020	VRS-TV1JD562J	2125 5.6KOHM 5% 1/10W SMD	S AA	AA
R 1021	VRS-TV1JD472J	2125 4.7KOHM 5% 1/10W SMD	S AA	AA
R 1022	VRS-TV1JD472J	2125 4.7KOHM 5% 1/10W SMD	S AA	AA
R 1023	VRS-TV1JD472J	2125 4.7KOHM 5% 1/10W SMD	S AA	AA
R 1024	VRS-TV1JD472J	2125 4.7KOHM 5% 1/10W SMD	S AA	AA
R 1025	VRS-TV1JD472J	2125 4.7KOHM 5% 1/10W SMD	S AA	AA
R 1026	VRS-TV1JD000J	2125 0 OHM 5% 1/10W SMD	S AA	AA
R 1027	VRD-RA2BE101J	RES 100 OHM 5% 1/8W	S AA	AA
R 1028	VRD-RA2BE101J	RES 100 OHM 5% 1/8W	S AA	AA
R 1029	VRD-RA2BE101J	RES 100 OHM 5% 1/8W	S AA	AA
R 1030	VRS-TV1JD101J	2125 100 OHM 5% 1/10W SMD	S AA	AA
R 1031	VRS-TV1JD101J	2125 100 OHM 5% 1/10W SMD	S AA	AA
R 1032	VRS-TV1JD393J	2125 39KOHM 5% 1/10W SMD	S AA	AA
R 1033	VRS-TV1JD472J	2125 4.7KOHM 5% 1/10W SMD	S AA	AA
R 1034	VRS-TV1JD154J	2125 150KOHM 5% 1/10W SMD	S AA	AA
MISCELLANEOUS PARTS				
△ F 0701	QFS-C3226CEZZ	FUSE T3.15AH 250V	S AC	AE
F 0701	QFSD1001BMZZ	FUSE HOLD.EYF52BC=PANASON	S AA	AA
F 0701	QFSD1002BMZZ	FUSE HOLD.EYF52BC=PANASON	S AA	AA
(H)	QCNW-2834BMZZ	WIRE (H) 14"	S AA	AD
(K)	QCNW-2835BMZZ	WIRE (K) 14"	S AA	AE
A 0000	QPLGN0304CEZZ	PLUG	S AA	AB
G 0000	QPLGN0207CEZZ	PLUG	S AA	AA
S 0000	QPLGN0241CEZZ	PLUG	S AA	AA
CF 0201	RFILC0020CEZZ	FILTER SIF TRAP (TAPED)	S AE	AE
F 0000	QPLGN0505CEZZ	PLUG	S AA	AB
F 0401	RBLN-0037CEZZ	BALUN FBA04HA90088-00 T/Y	S AB	AB
FB 0301	RBLN-0037CEZZ	BALUN FBA04HA90088-00 T/Y	S AB	AB
FB 0701	RBLN-0020CEZZ	BALUNE	S AA	AB
FB 0702	RBLN-0037CEZZ	BALUN FBA04HA90088-00 T/Y	S AB	AB
J 0019	VRS-TV1JD332J	2125 3.3KOHM 5% 1/10W SMD	S AA	AA
J 0054	VRS-TV1JD000J	2125 0 OHM 5% 1/10W SMD	S AA	AA
J 0056	VRS-TQ2BD000J	3216 0 OHM 5% 1/8W SMD	S AA	AA
J 0061	VRS-TV1JD000J	2125 0 OHM 5% 1/10W SMD	S AA	AA
J 0062	VRS-TV1JD000J	2125 0 OHM 5% 1/10W SMD	S AA	AA
J 0067	RC-FZ4105BMNJ	POL FILM C 1MF 50V 5% ECQ-V PANASONIC	S AA	AD
JF 0016	VRS-TV1JD000J	2125 0 OHM 5% 1/10W SMD	S AA	AA
JF 0017	VRS-TV1JD000J	2125 0 OHM 5% 1/10W SMD	S AA	AA
JF 0018	VRS-TV1JD000J	2125 0 OHM 5% 1/10W SMD	S AA	AA
JL 0005	QCNW-3055BMZZ	WIRE BETWEEN GNDS CA-1	S AA	AB
RMC0001	RRMCU0222CEZZ	R/C RECEIVER	S AD	AG
△ S 0701	QSW-P0588CEZZ	SWITCH ESB91632A-V	S AH	AM
S 1001	QSW-K0079GEZZ	TACTILE SWITCH	S AA	AA
S 1002	QSW-K0079GEZZ	TACTILE SWITCH	S AA	AA
S 1003	QSW-K0079GEZZ	TACTILE SWITCH	S AA	AA
S 1004	QSW-K0079GEZZ	TACTILE SWITCH	S AA	AA
SC 0401	QSOC22107BMZZ	SOCKET	S AF	AE
PWB-B		SOCKET UNIT		
		TRANSISTORS		
Q 0870	RH-TX0181BMZZ	TRT BF422 TOSHIBA	S AA	AC
Q 0871	RH-TX0181BMZZ	TRT BF422 TOSHIBA	S AA	AC
Q 0872	RH-TX0181BMZZ	TRT BF422 TOSHIBA	S AA	AC
Q 0883	RH-TX0180BMZZ	TRT BF421 TOSHIBA	S AA	AB
Q 0885	RH-TX0180BMZZ	TRT BF421 TOSHIBA	S AA	AB
Q 0887	RH-TX0180BMZZ	TRT BF421 TOSHIBA	S AA	AB

REF No.	PARTS	DESCRIPTION	* SN CODE	EX CODE
DIODES				
D 0811	RH-DX0551BMZZ	DIODE LL4148 TFK SMD	S AA	AA
D 0812	RH-DX0551BMZZ	DIODE LL4148 TFK SMD	S AA	AA
D 0860	RH-DX0551BMZZ	DIODE LL4148 TFK SMD	S AA	AA
D 0861	RH-DX0551BMZZ	DIODE LL4148 TFK SMD	S AA	AA
D 0862	RH-DX0551BMZZ	DIODE LL4148 TFK SMD	S AA	AA
COILS				
L 0861	VP-CF120K0000	PEAK COIL 12UH 10%	S AB	AC
CAPACITORS				
C 0860	VCCCTV1HH471J	CERAM C 470PF 50V 2125SMD	S AA	AA
C 0861	VCCCTV1HH471J	CERAM C 470PF 50V 2125SMD	S AA	AA
C 0862	VCCCTV1HH471J	CERAM C 470PF 50V 2125SMD	S AA	AA
C 0871	VCCCTV1HH471J	CERAM C 470PF 50V 2125SMD	S AA	AA
C 0872	VCCCTV1HH471J	CERAM C 470PF 50V 2125SMD	S AA	AA
C 0873	VCCCTV1HH471J	CERAM C 470PF 50V 2125SMD	S AA	AA
C 0874	VCKYPA2HB102K	CERAM C 1NF 10% 500V	S AA	AA
C 0876	VCKYPB3DE472Z	C DE1110-1E47222K MURATA	S AA	AC
C 0878	VCEAGA2DW106M	ELEC C 10UF 20% 200V	S AA	AC
C 0879	VCCCPA1HH101J	C CAPACITOR	S AA	AA
RESISTORS				
R 0862	VRS-PU3DB153J	MET OX RES 15 KOHM 5% 2W	S AA	AC
R 0864	VRS-PU3DB153J	MET OX RES 15 KOHM 5% 2W	S AA	AC
R 0866	VRS-PU3DB153J	MET OX RES 15 KOHM 5% 2W	S AA	AC
R 0879	VRS-TV1JD471J	2125 470 OHM 5% 1/10W SMD	S AA	AA
R 0880	VRS-TV1JD471J	2125 470 OHM 5% 1/10W SMD	S AA	AA
R 0881	VRS-TV1JD471J	2125 470 OHM 5% 1/10W SMD	S AA	AA
R 0883	VRD-RA2HD272J	RES 2.7KOHM 5% 1/2W	S AA	AA
R 0885	VRD-RA2HD272J	RES 2.7KOHM 5% 1/2W	S AA	AA
R 0887	VRD-RA2HD272J	RES 2.7KOHM 5% 1/2W	S AA	AA
R 0888	VRS-TV1JD471J	2125 470 OHM 5% 1/10W SMD	S AA	AA
R 0892	VRS-TV1JD102J	2125 1KOHM 5% 1/10W SMD	S AA	AA
R 0893	VRS-TV1JD102J	2125 1KOHM 5% 1/10W SMD	S AA	AA
R 0894	VRS-TV1JD102J	2125 1KOHM 5% 1/10W SMD	S AA	AA
R 0898	VRS-TV1JD471J	2125 470 OHM 5% 1/10W SMD	S AA	AA
R 0899	VRS-TV1JD471J	2125 470 OHM 5% 1/10W SMD	S AA	AA
MISCELLANEOUS PARTS				
△ SC 0881	QSOCV0842CEZZ	CRT SOCKET	S AD	AG
L 0003	QTIPM0017CEFM	TIP	S AA	AA
PWB-C		HEADPHONE UNIT		
		COILS		
L 0302	VP-NM3R3MR19N	COIL 3.3UH SMD	S AA	AC
		CAPACITORS		
C 0310	VCKYTV1HF473Z	CERAM C 47NF 50V 2125SMD	S AA	AA
C 0311	VCKYTV1HF473Z	CERAM C 47NF 50V 2125SMD	S AA	AA
		RESISTORS		
R 0316	VRS-TV1JD471J	2125 470 OHM 5% 1/10W SMD	S AA	AA
R 0317	VRS-TV1JD471J	2125 470 OHM 5% 1/10W SMD	S AA	AA
		MISCELLANEOUS PARTS		
(S)	QCNW-2761BMZZ	WIRE (AB) 2WAYS 32" 16.9	S AA	AD
(SH)	QPLGN0241CEZZ	PLUG	S AA	AA
(SH)	QCNW-2676BMZZ	SPEAKER WIRE	S AC	AE
(SH)	QPLGN0241CEZZ	PLUG	S AA	AA
J 0301	QJAKJ0047CEZZ	EARPHONE JACK HSJ0998-72	S AA	AG
		MISCELLANEOUS PARTS		
△	QACCZ2100BMSA	AC CORD	S AH	AR
	VSP0080PBL6YS	SPEAKER 2.0W 32 OHM DAIWA	S AE	AH
	TINS-6853BMNO	OWNERS MANUAL 37GQ20SDES	S AA	AC
	TINS-6854BMNO	QUICK REFERENCE GUIDE 37GQ20SDES	S AA	AA

REF No.	PARTS	DESCRIPTION	* SN CODE	EX CODE
	RRMCG1059BMSA	REMOTE CONTROL UNIT	S AL	AS
CABINET PARTS				
1	CCABA1284BMV0	CABINET SET 37GQ20S BLACK	S AL	AX
1	CCABA1303BMV0	CABINET SET 37GQ20SDES METALLIC BLUE 026	S AQ	BB
1	CCABA1291BMV0	CABINET SET 37GQ21S BLACK	S AM	AX
1	CCABA1293BMV0	CABINET SET 37GQ21SESY YELLOW	S AQ	BB
1	CCABA1294BMV0	CABINET SET 37GQ21SESR RED	S AR	BC
1.2	HBDGB1017BMSB	SHARP BADGE	S AA	AC
1.3	HDECQ0036BMSA	R/C DECORATION	S AA	AB
1.4	HDECQ0035BMSA	LED DECORATION	S AA	AB
1.5	JBTN-1047BMSA	UP/DOWN BUTTON BLACK	S AA	AD
1.5	JBTN-1047BMSD	UP/DOWN BUTTON 37GQ20SDES METALLIC BLUE 026	S AA	AE
1.5	JBTN-1047BMSC	UP/DOWN BUTTON YELLOW "EM"	S AA	AE
1.6	JBTN-1046BMSA	POWER BUTTON BLACK	S AA	AB
1.6	JBTN-1046BMSD	POWER BUTTON 37GQ20SDES METALLIC BLUE 026	S AA	AC
1.6	JBTN-1046BMSC	POWER BUTTON YELLOW "EM"	S AA	AB
△ 2	GCABB1107BMKA	REAR CAB. 37GQ-20S/21S BLACK	S AH	AU
△ 2	GCABB1107BMKB	REAR CAB. 37GQ21SESY YELLOW	S AH	AV

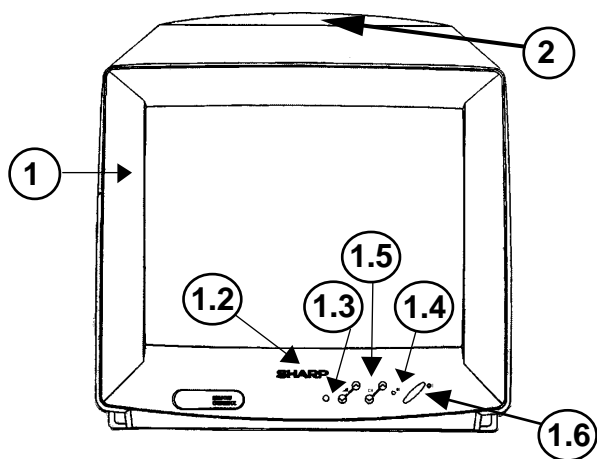

TROUBLESHOOTING TABLES.

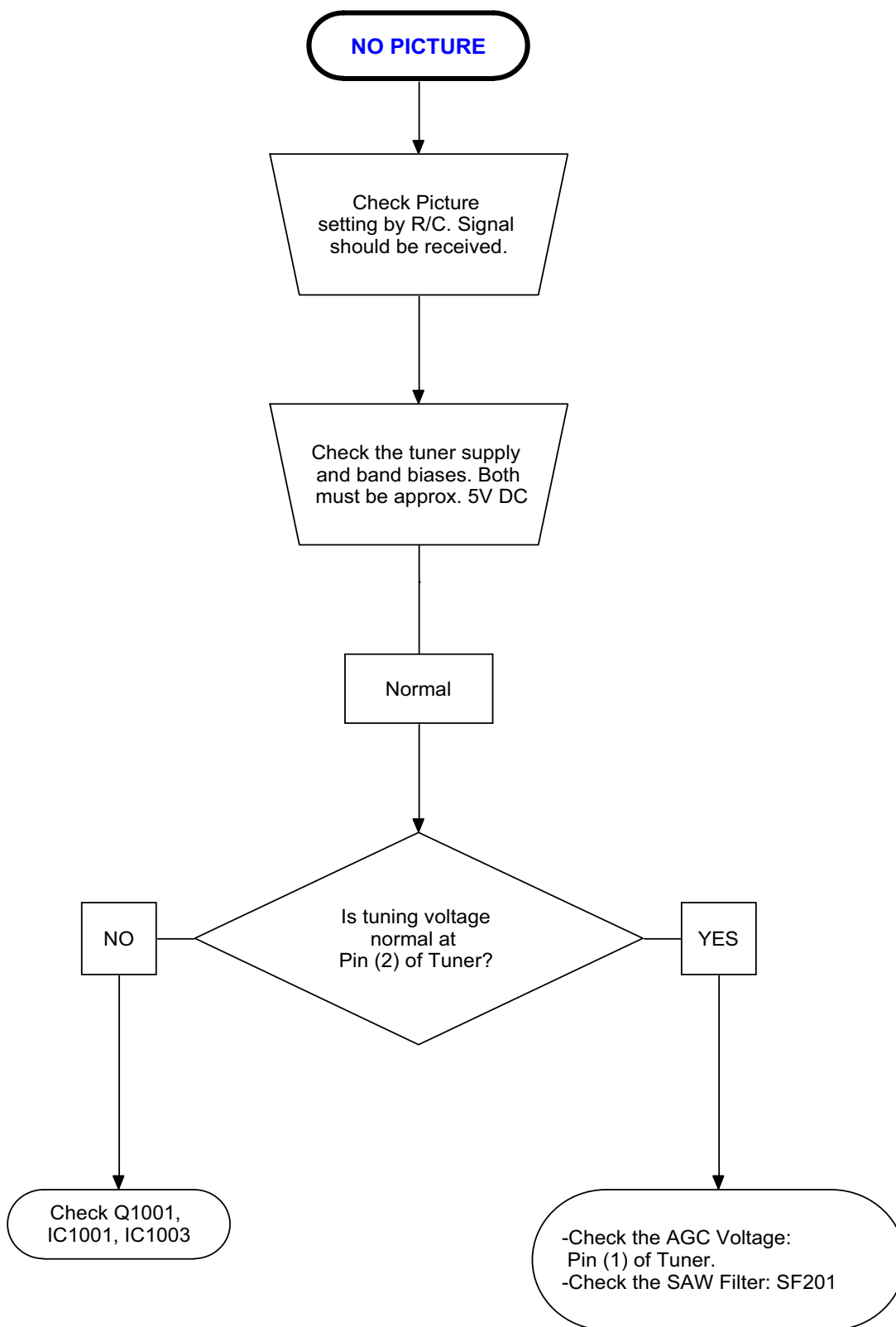

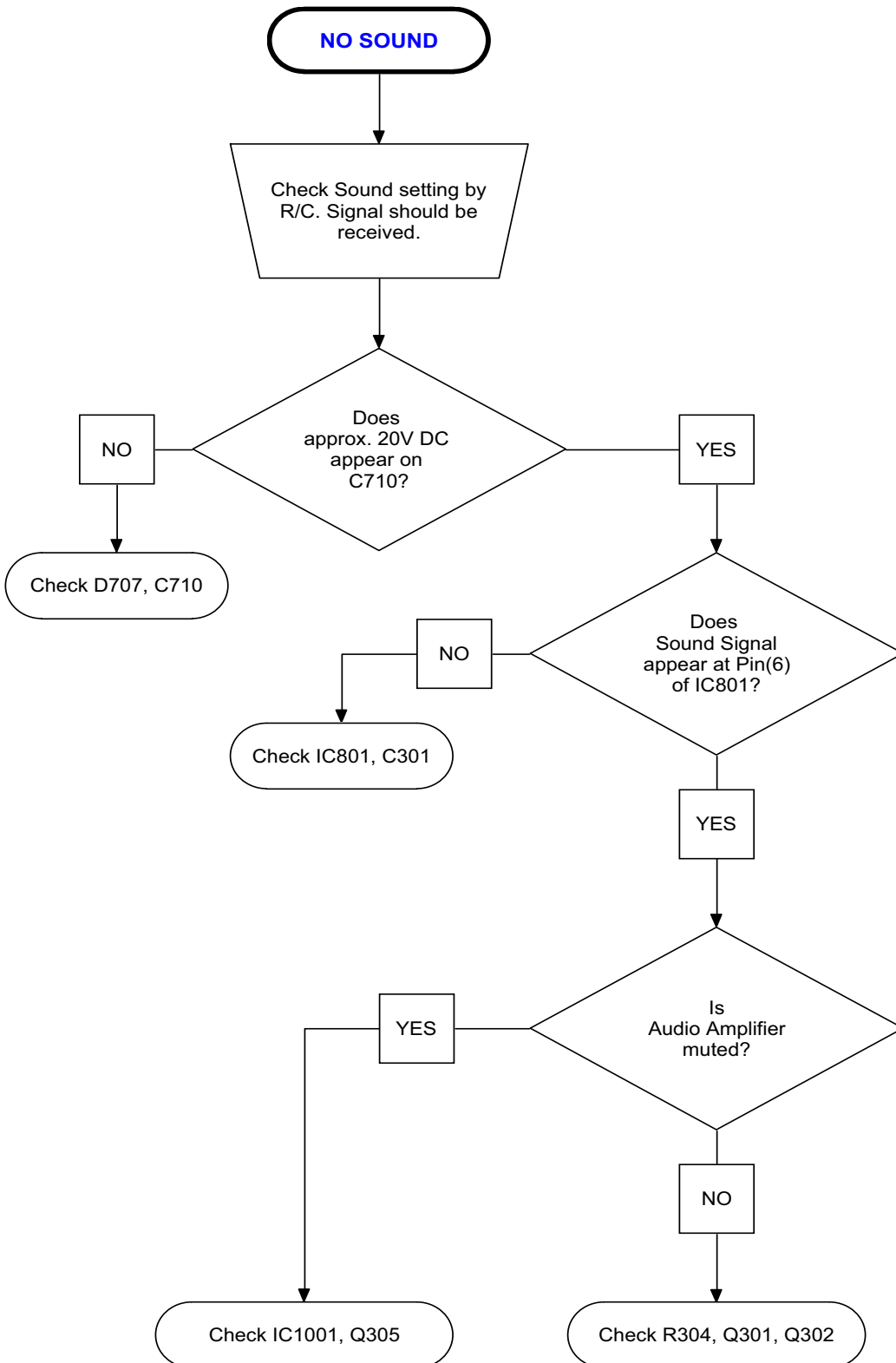

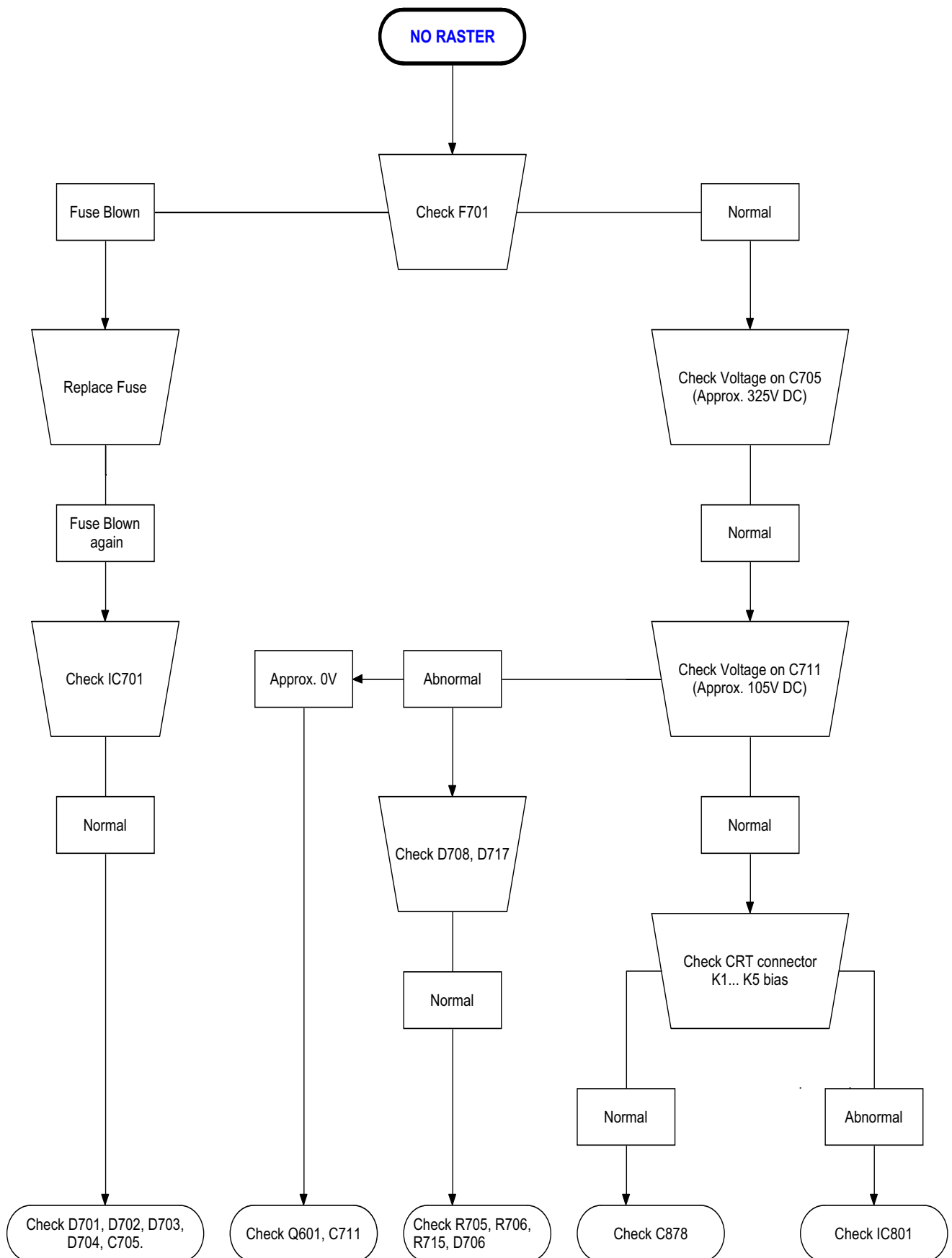

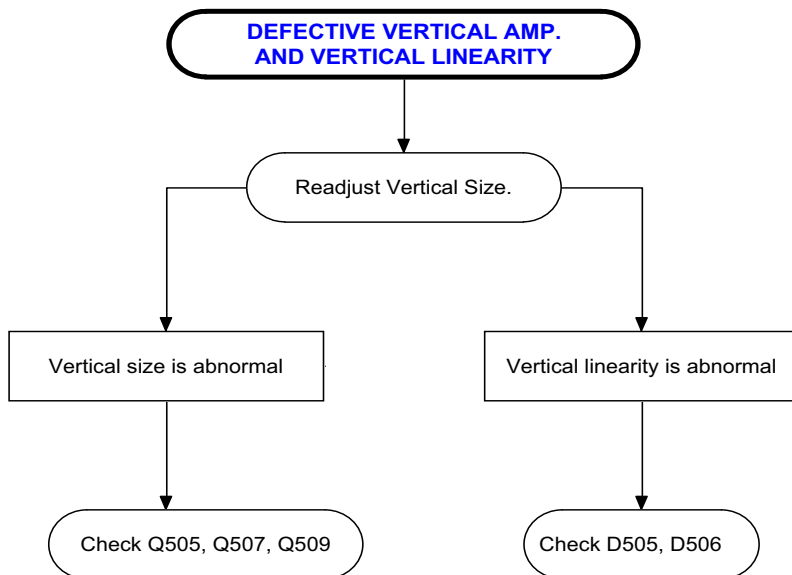
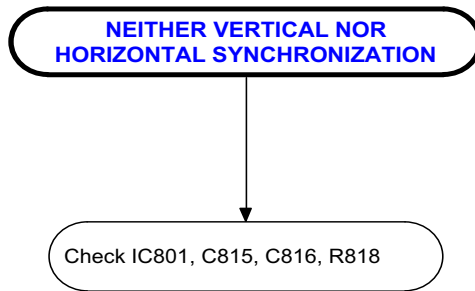
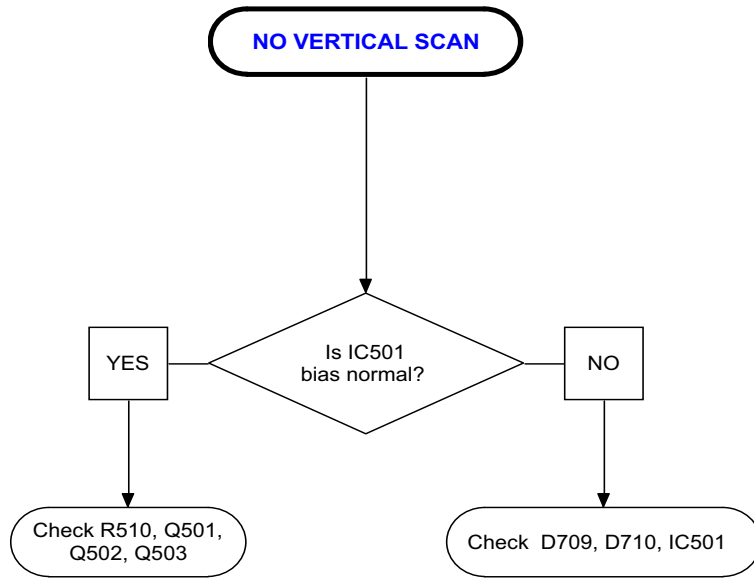

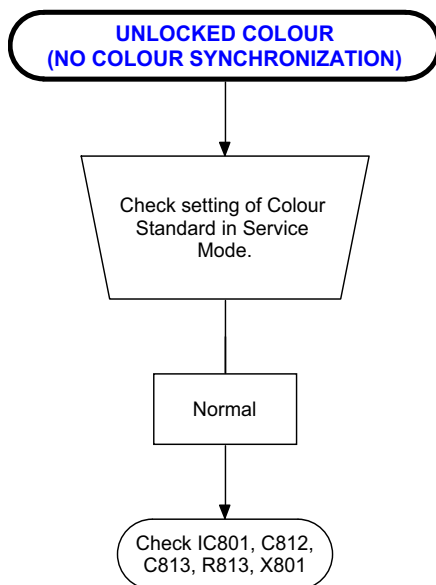
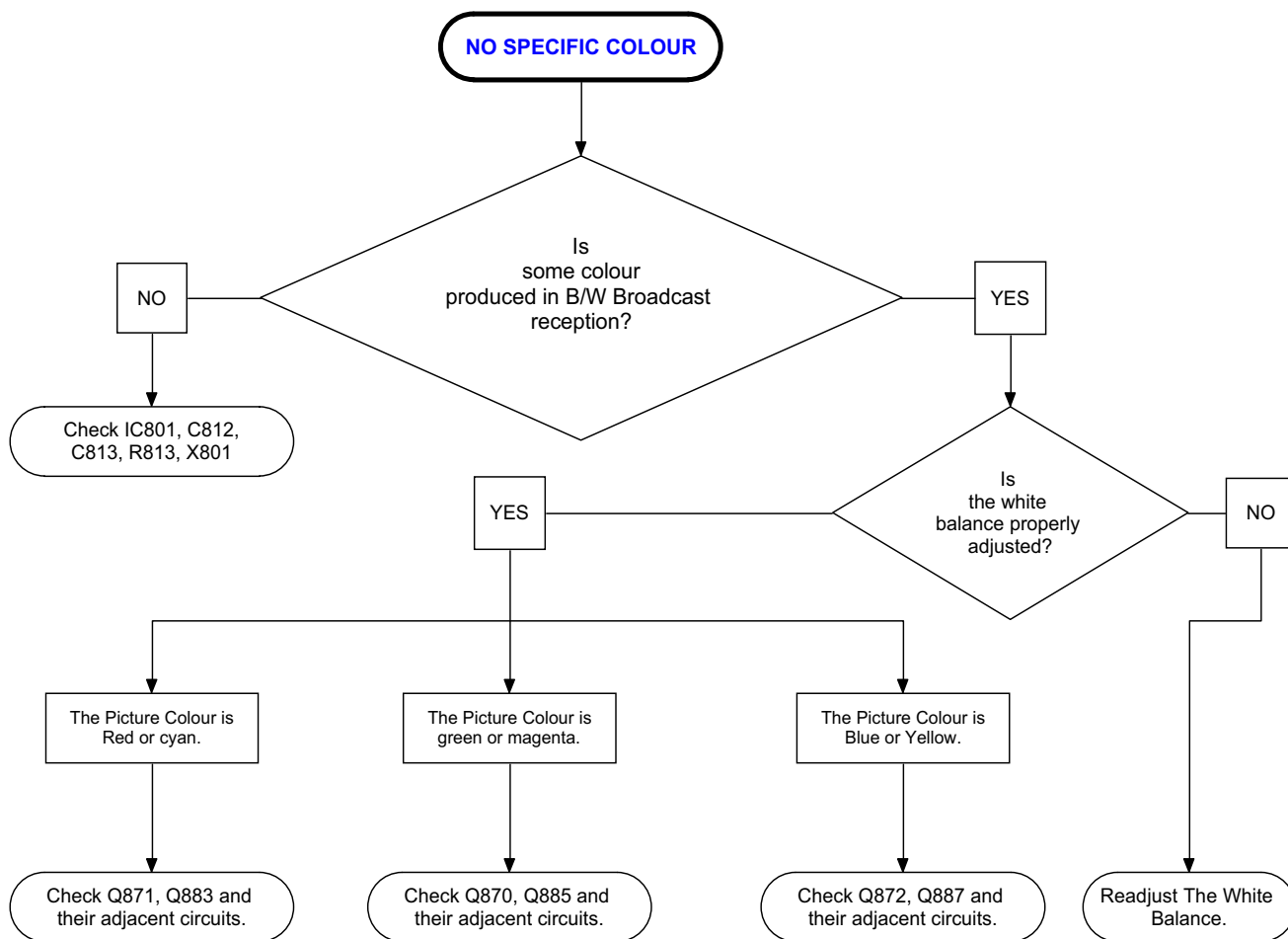

SHARP

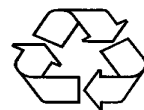

RECYCLED PAPER

PRINTED BY:

ON: